

INSTRUCTION MANUAL

1/10 Scale 4WD RC Nitro & Electric Powered Car



Spirit N1/N2

RH1006 - N1(Single Speed)

RH1007 - N2 (Two Speed)



Bulldog N1/N2

RH1021-Bulldog N1

RH1022 Bulldog N2

RH1006 SPIRIT N1 (Single Speed)

RH1006 Specs. :

1. Length: 415 mm
2. Width: 255 mm
3. Height: 142 mm
4. Wheelbase: 275/280 mm
5. Gear Ratio: 9.1:1
6. Tyre: $\varnothing 88 \times 34$ mm (FRONT)
 $\varnothing 88 \times 39$ mm (REAR)
7. Weight: 1840 g (SPIRIT N1)

Standard Equipments:

1. Steering Servo: 3kg/cm
2. Throttle Servo: 3kg/cm
3. Engine: G0.18 or SH.18
4. Radio: 2CH AM

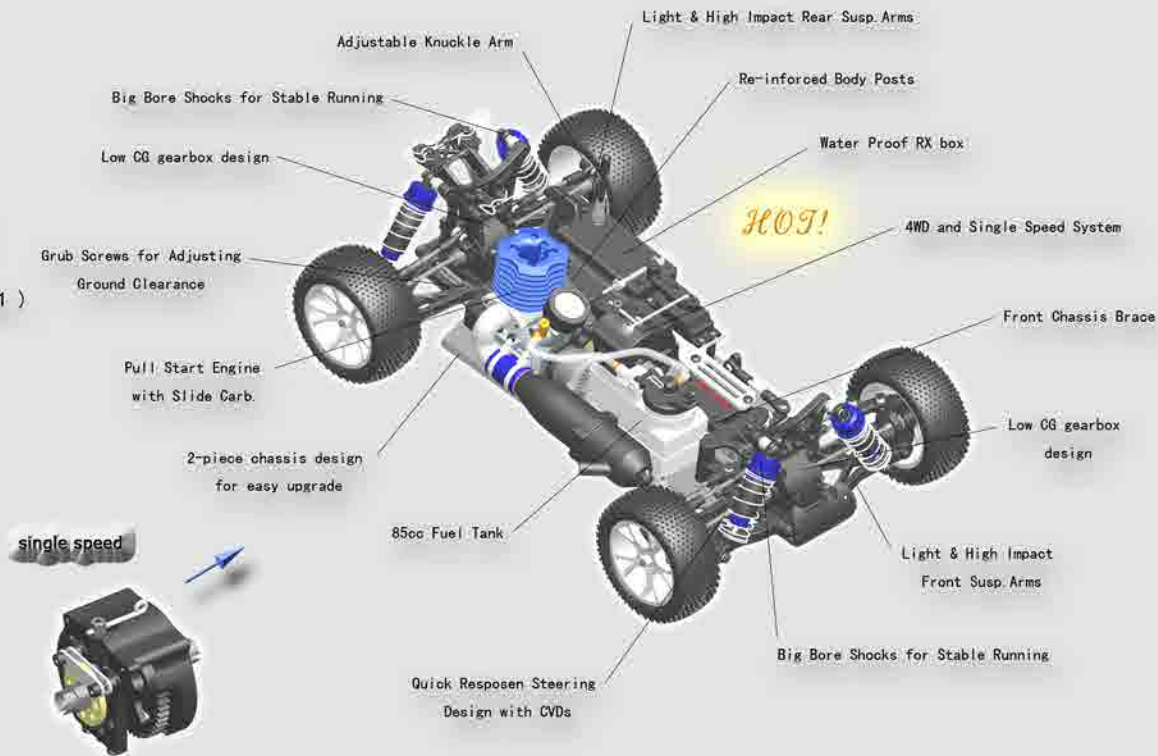

RH1007 SPIRIT N2 (Two Speed)

RH1007 Specs. :

1. Length: 415 mm
2. Width: 255 mm
3. Height: 142 mm
4. Wheelbase: 275/280 mm
5. Gear Ratio: 6.1:1 (H)
9.1:1 (L)
6. Tyre: $\varnothing 88 \times 34$ mm (FRONT)
 $\varnothing 88 \times 39$ mm (REAR)
7. Weight: 1900 g (SPIRIT N2)

Standard Equipments:

1. Steering Servo: 3kg/cm
2. Throttle Servo: 3kg/cm
3. Engine: G0.18 or SH.18
4. Radio: 2CH AM

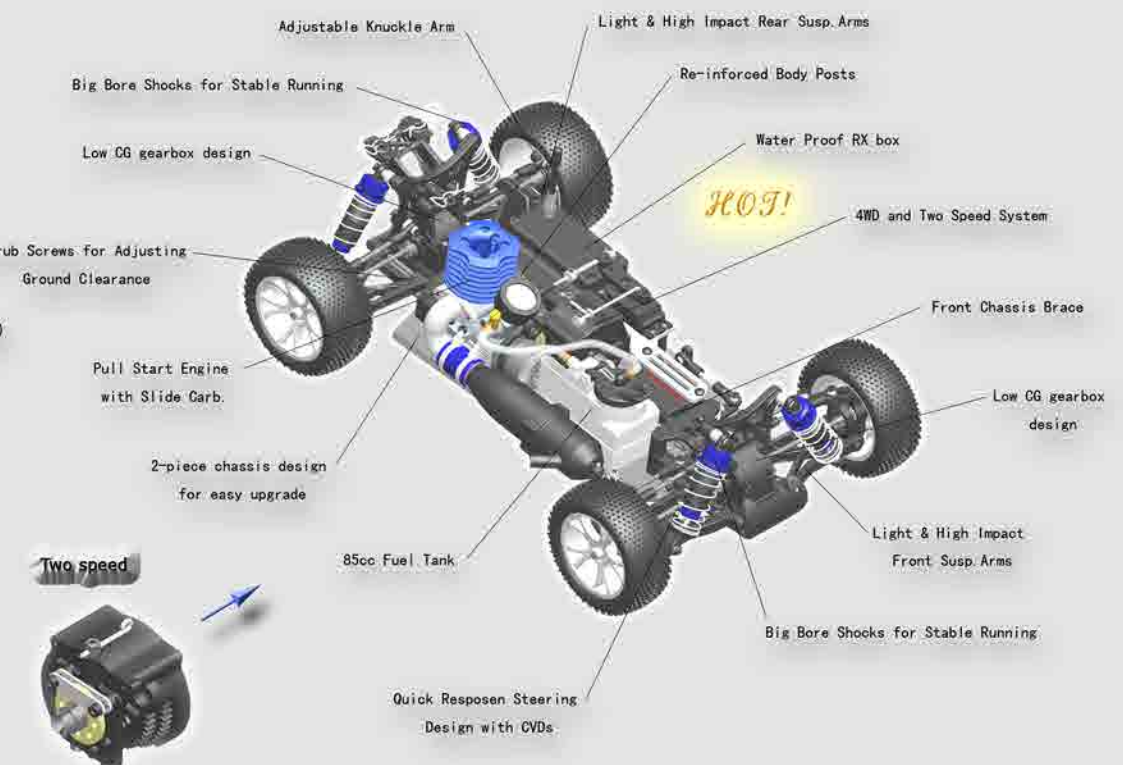

FRONT & REAR SHOCK ASSEMBLY

Front Shocks

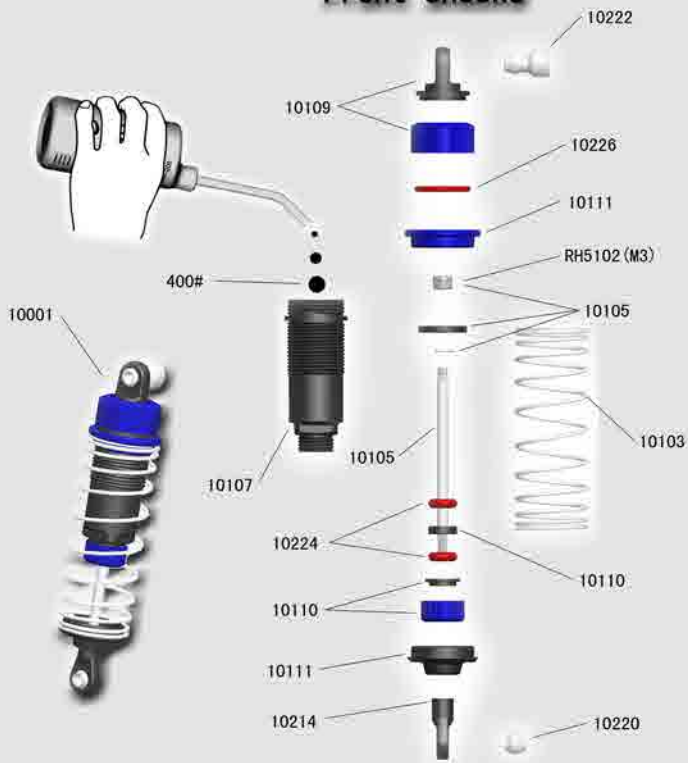

(Dia. 3-1)

Rear Shocks

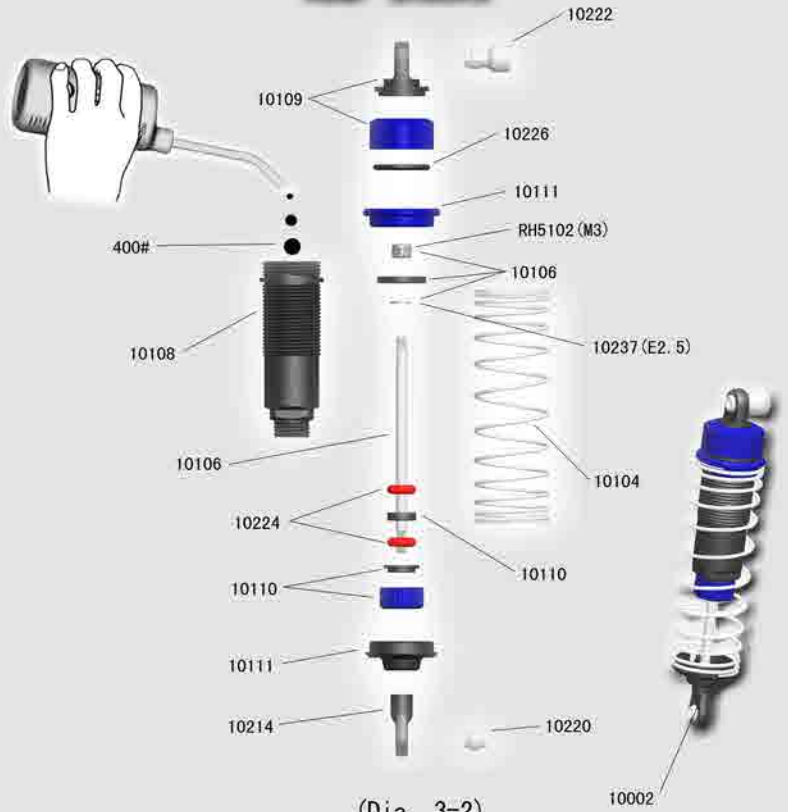

(Dia. 3-2)

Chassis Assembly

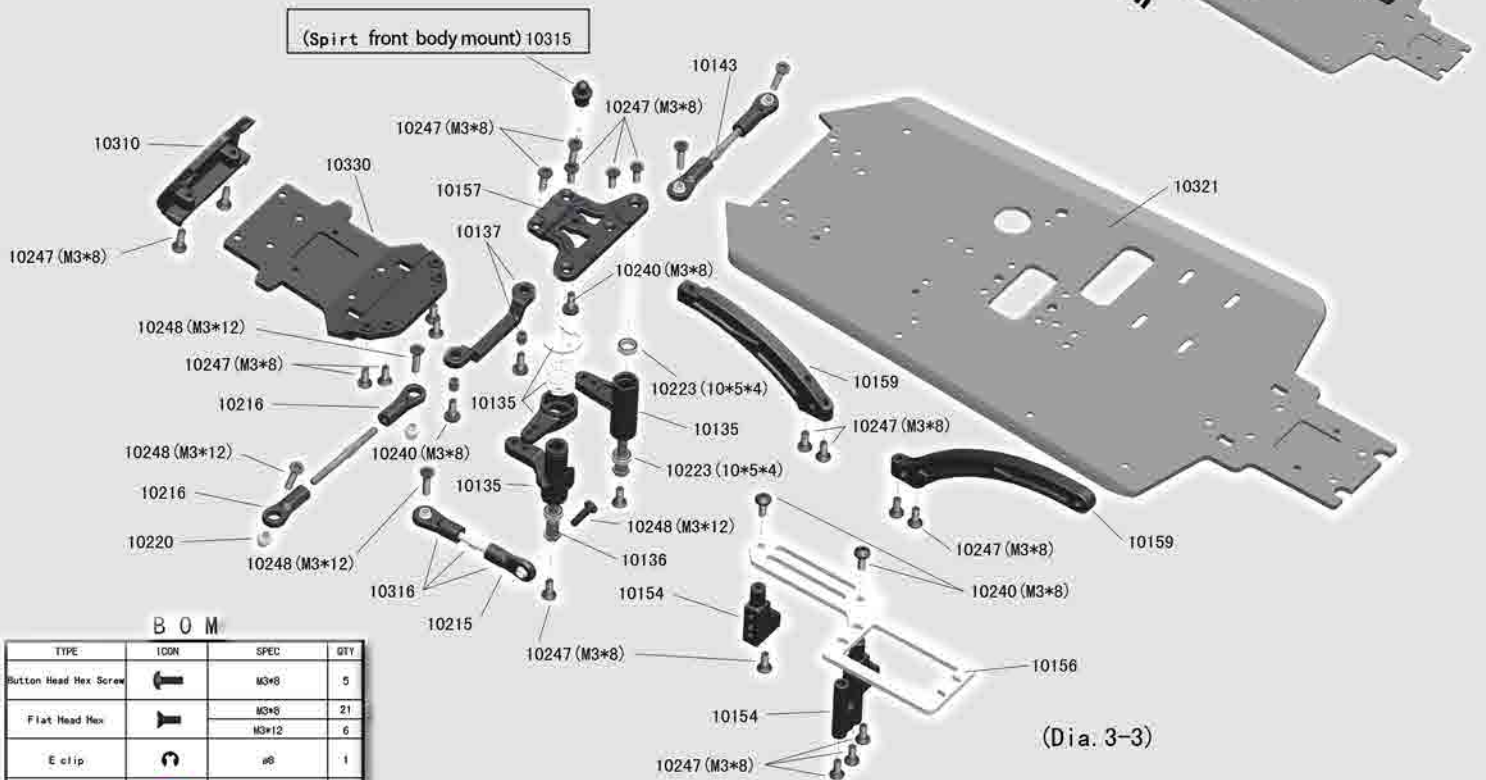

(Dia. 3-3)

B O M

TYPE	ICDN	SPEC	QTY
Button Head Hex Screw		M3*8	5
Flat Head Hex		M3*8	21
		M3*12	6
E clip		#8	1
Ball Bearing		#8*4*2.5	3

B O M

TYPE	ICDN	SPEC	QTY
Round Head Self Tapping Hex. Screw		2*10	4
Button Head Hex. Screw		M3*8	2
		M3*12	2
		M3*4	4
Cap Head Hex. Screw		M3*18	2
		M3*10	10
Flat Head Hex.		M3*12	3
		M3*14	4
		M3*18	2
		M3*36	2
		M3*5	2
Set Screw		M4*4	1
		M4*10	2
Ring Self Tapping Screw		3*4	2
Washer		a6*3, 1*0.2	2
Nylon Lock Nut		M3	2
E clip		a2.5	5
O'Ring		a6.05*a8.55*a1.55	4
		a6*a3*a2.5	4
		a15.6*a12.6*a1.5	2
Ball Bearing		a15*a10*4	2
		a10*a5*4	6

Front Assembly



(Dia. 4-1)

Gearbox Assembly



(Dia. 4-2)

Diff. Box

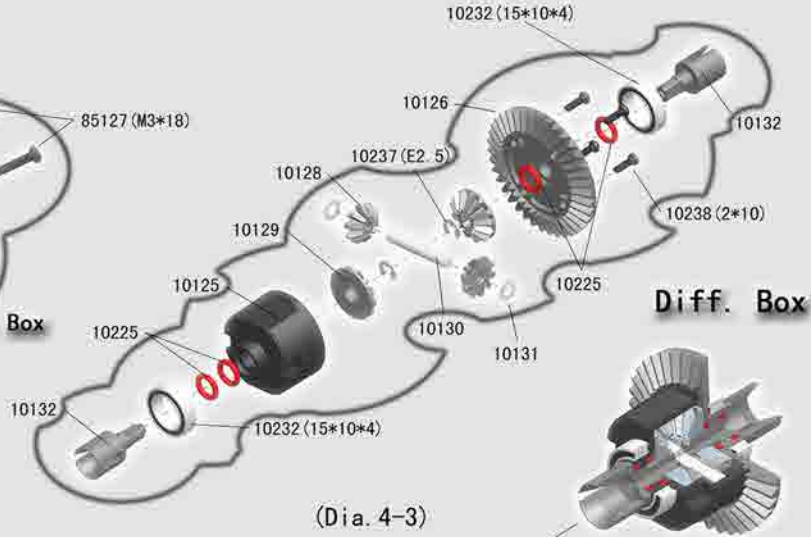

(Dia. 4-3)

Rear Assmely

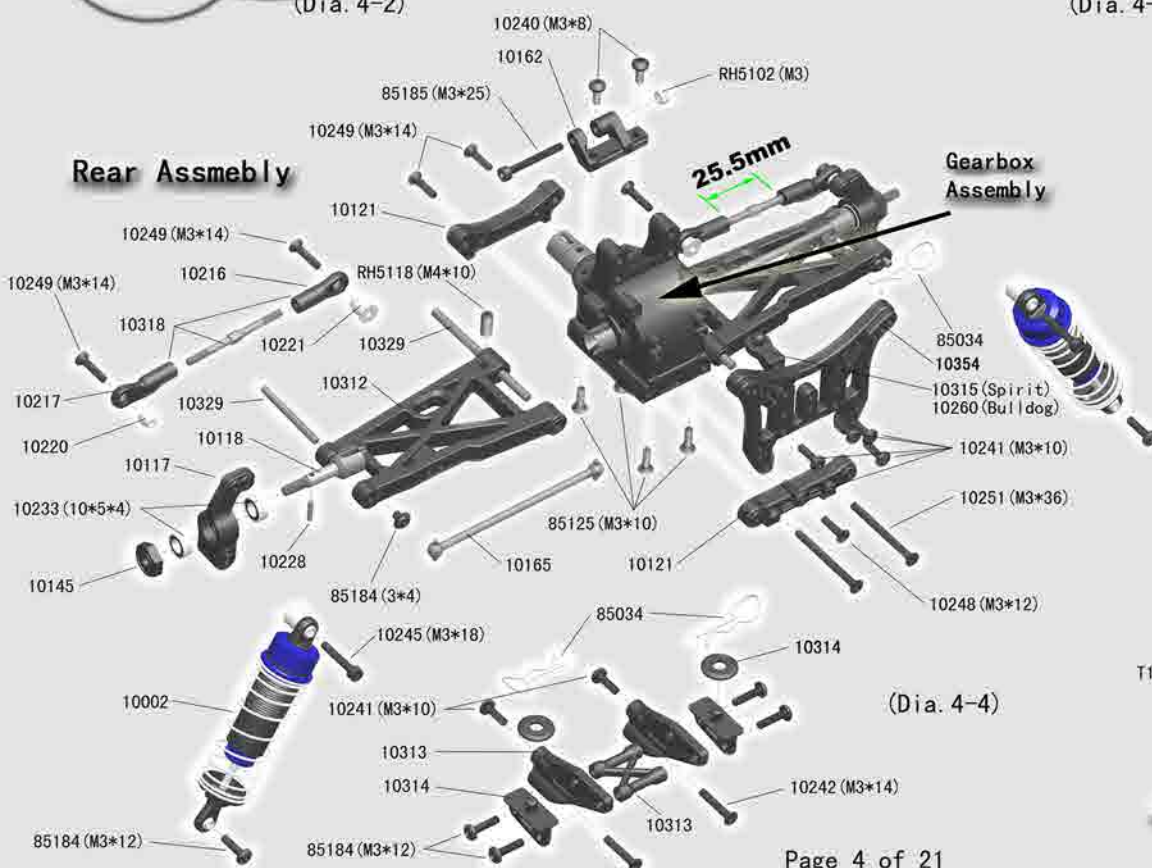

(Dia. 4-4)

B O M

TYPE	ICDN	SPEC	QTY
Round Head Self Tapping Hex. Screw		2*10	4
Button Head Hex. Screw		M3*8	2
		M3*10	7
		M3*18	6
Cap Head Hex. Screw		M3*25	1
		M3*10	4
Flat Head Hex.		M3*12	3
		M3*14	4
		M3*18	4
		M3*36	2
		M4*4	1
Set Screw		M4*10	2
Ring Self Tapping Screw		3*4	2
Washer		a6*3, 1*0.2	2
Nylon Lock Nut		M3	3
E clip		a2.5	5
O'Ring		a6.05*a8.55*a1.55	4
		a6*a3*a2.5	4
		a15.6*a12.6*a1.5	2
Ball Bearing		a15*a10*4	2
		a10*a5*4	6

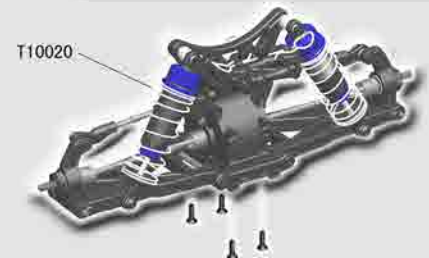

Spirit/Bulldog N1 and N2 are almost in structure but the central transmission (Diagram 5-2 and 5-3).

For hobbyists, we have optional front and rear sway bar for upgrade, which adds higher racing performance,

Optional Front & Rear Sway Bar #10325.

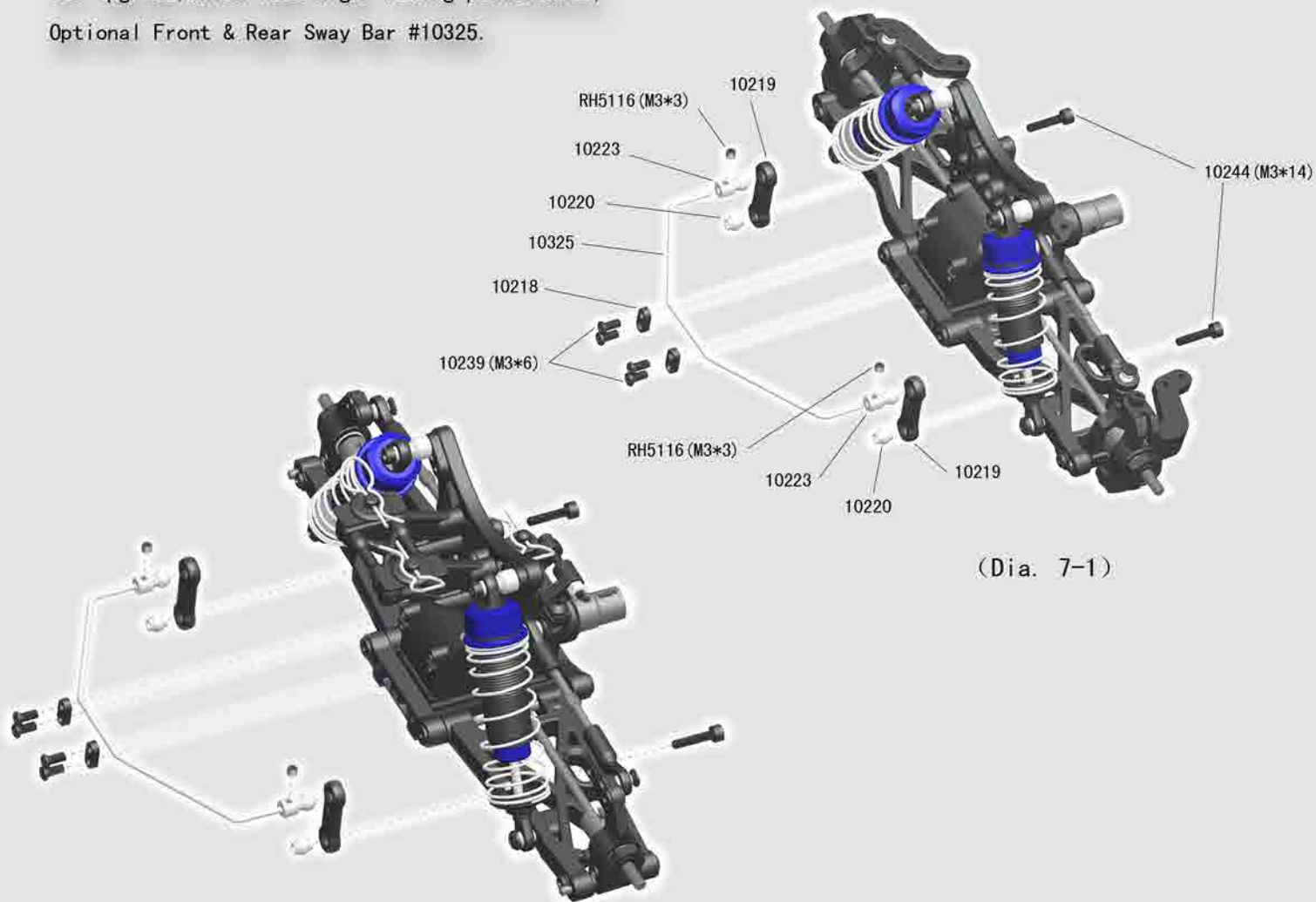

(Dia. 7-1)

(Dia. 7-2)

Spirit (N1/N2)

Bulldog (N1/N2)

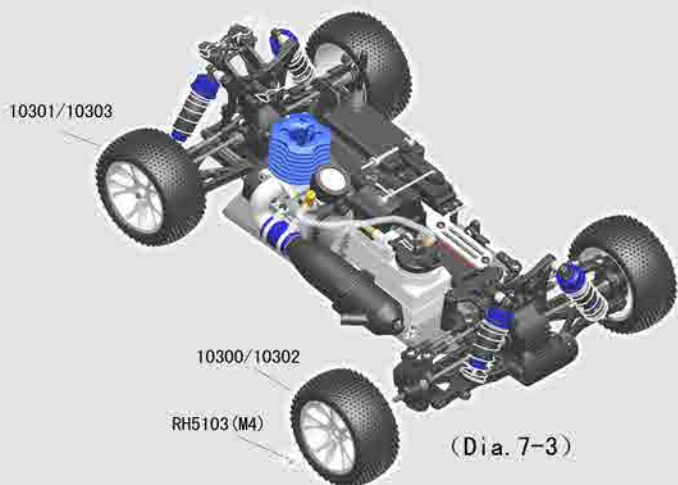

(Dia. 7-3)

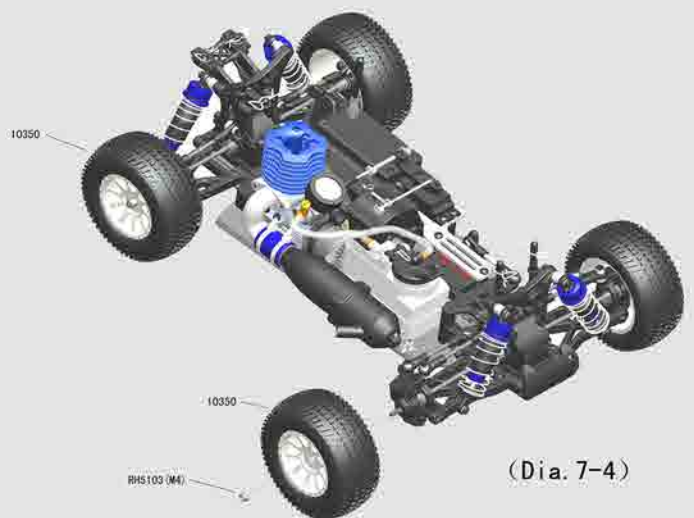

(Dia. 7-4)

Assembly Steps (Spirit/Bulldog N1 and N2) :

1. Fasten the fuel tank posts to the chassis, then the fuel tank assembly. (See Dia. 6-6)

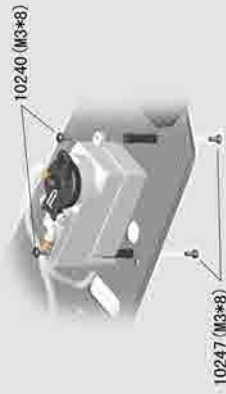

2. Assemble Chassis. (See Dia. 3-3)



3. Assemble the front assembly to the chassis. (See Dia. 4-1)



4. Assemble the rear assembly to the chassis. (See Dia. 4-4)



5. Tighten the wheels. (See Dia. 6-4 or 6-5)



6. Assemble central transmission and rear central drive shaft to the chassis. (See Dia. 5-2 or 5-3)

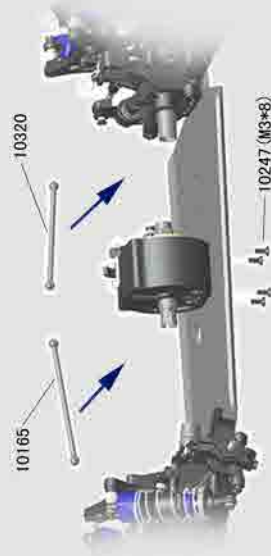



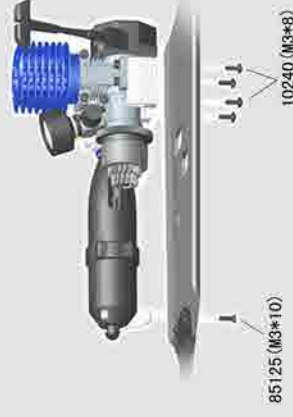



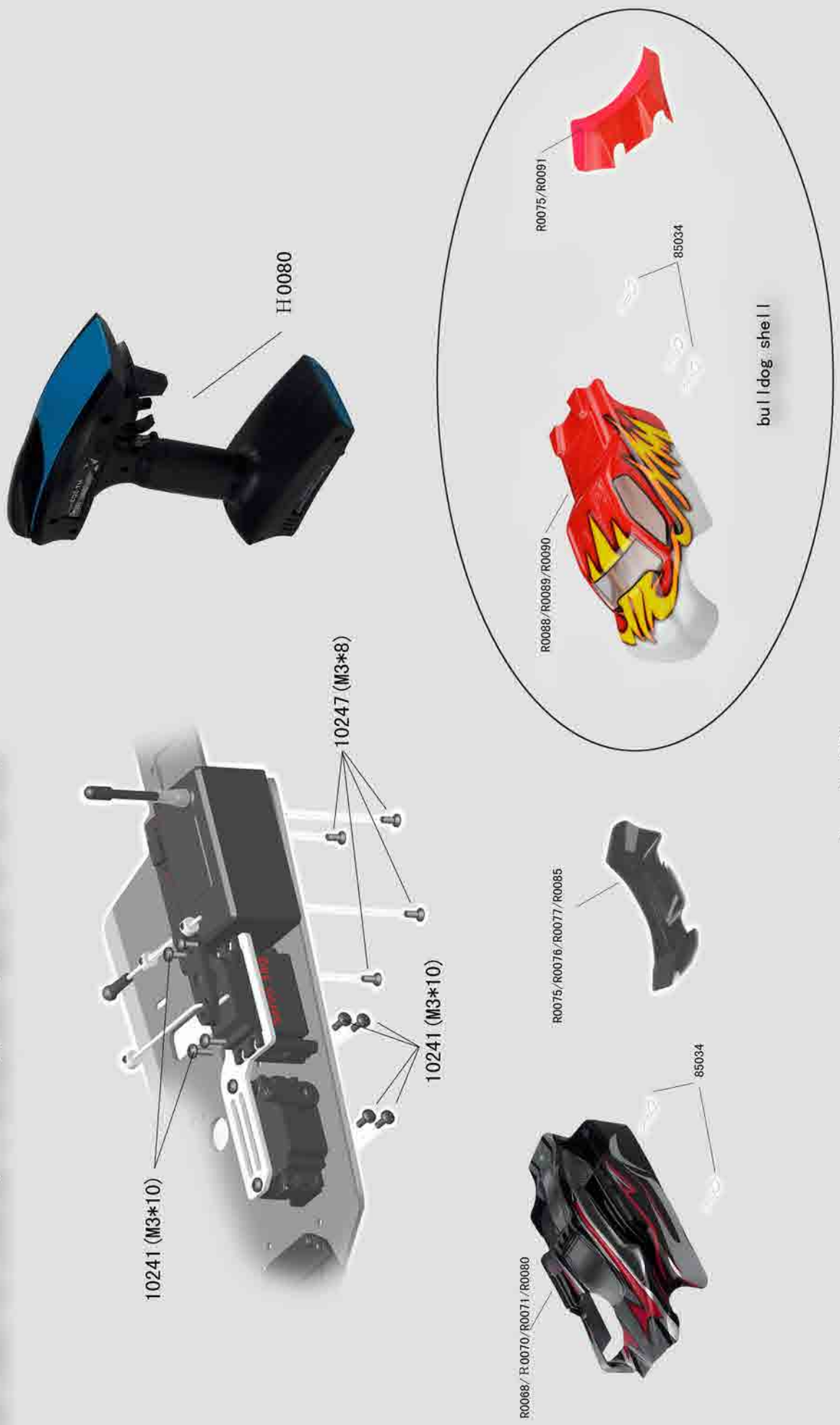







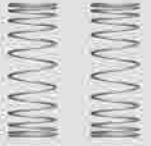
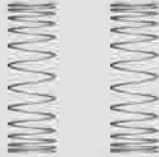



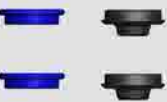

7. Tighten the engine assembly to the chassis. (See Dia. 5-1)





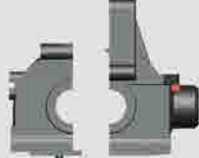







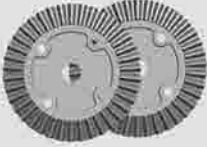









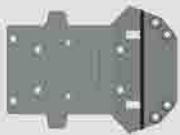

8. Finally assemble the receiver box assembly, throttle/steering servos assembly to the chassis. Setup the radio system and then assemble the cutted body to the body posts. (See Dia. 6-1, 6-2, 6-3)















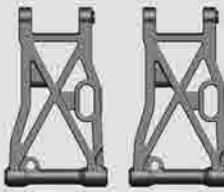
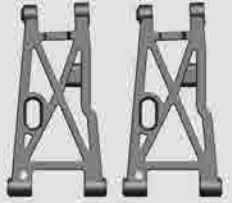









Common Part List

<p>10353 - Front Shock Tower 1pc</p> 	<p>10354 -Rear Shock Tower 1pc</p> 	<p>10001-Front Shocks 2pc (Alum Caps)</p> 	<p>10002-Rear shock tower 2pc(Alum caps)</p> 
<p>10103-Front Shock Spring 2pc</p> 	<p>10104-Rear Shock Spring 2pc</p> 	<p>10105-Front Shock Shaft & Piston Set 2sets</p> 	<p>10106-Rear Shock Shaft & Piston Set 2sets</p> 
<p>10107-Front Shock Body 2pc</p> 	<p>10108-Rear Shock body 2pc</p> 	<p>10109-Shock Upper Cap 2sets</p> 	<p>10110-Shock Lower Caps 2sets</p> 
<p>10111-Shock Lower holder & Adjust Ring 2sets</p> 	<p>10114-Steering Knuckle Arm 1set</p> 	<p>10115-Uprights 2pc</p> 	<p>10117-Rear Hub Carrier 2pc</p> 
<p>10118-Rear Drive Shaft 2pc</p> 	<p>10120-Front Susp. Holders 2pc</p> 	<p>10121-Rear Susp. Holders 2pc</p> 	<p>10123-Gearbox Housing Set 2pos</p> 
<p>RH5526-Diff 16T Gear Washer 6pcs</p> 	<p>10124-Diff Drive Gear w/pin 2sets</p> 	<p>10003-Diff Gearbox Set 1set</p> 	<p>10125-Diff Case 2pcs</p> 

Common Part List

<p>10126-Diff Drive Spur Gear 2pcs</p>  <p>38T</p>	<p>10127-Diff Drive Gear 2pcs</p>  <p>13T</p>	<p>10128-Diff Bevel Gear S: 4pcs</p>  <p>10T</p>	<p>10129-Diff Bevel Gear B: 4pcs</p>  <p>13T</p>
<p>10130-Diff Pin 2pcs</p> 	<p>10131-Washer 6pcs</p> 	<p>10132-Diff Drive Cup 4pcs</p> 	<p>10133-Center Coupler 3pcs</p> 
<p>10135-Servo Saver (GP) 1set</p> 	<p>10136-Servo Saver Post 2pcs</p> 	<p>10137-Steering Ackerman</p> 	<p>10145-Wheel Hub 4pcs</p> 
<p>10146-Antenna Pipe Set 2sets</p> 	<p>10330-Chassis Front Part 1pc</p> 	<p>10300-Front buggy tyre set 2sets</p> 	<p>10301-Rear buggy tyre set 2sets</p> 
<p>10302-Front buggy tyre set 2sets</p> 	<p>10303-Rear buggy tyre set 2sets</p> 	<p>10304-Front Rim 2pcs 10332-Rear Rim 2pcs</p> 	<p>10305-Front tyres & inner foams 2sets</p> 
<p>10306-Rear tyres & inner foams 2sets</p> 	<p>10307-Front tyres & inner foams 2sets</p> 	<p>10308-Rear tyres & inner foams 2sets</p> 	<p>10309-Front CVD 2sets</p> 

















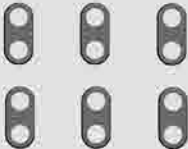



Part List

<p>10162-Chassis Brace mount .1pc.</p> 	<p>10310-Front Bumper buggy 1pc</p> 	<p>10311-Front Lower Susp. Arm 2pc</p> 	<p>10312-Rear Lower Susp. Arm 2pc</p> 
<p>10313-Wing Bracket 1set</p> 	<p>10314-Wing Holder 1set</p> 	<p>10315-Buggy Body Mount 1set</p> 	<p>10316-Servo Linkage 1pc</p>  <p>10317-Front Upper Susp. Arm 2sets</p> 
<p>10318-Rear Upper Susp. Arm 2sets</p> 	<p>10319-Steering Arm 2sets</p> 	<p>10320-Central Dongbone R. 1pc</p> 	<p>10321-Chassis Plate Rear Part 1pc</p> 
<p>10151-Manifold Gasket 6pc</p> 	<p>10153-Metal Bushing 8*5*2.5 6pc</p> 	<p>10154-Servo & Upper Plate Mounts 1set</p> 	
<p>10156-Upper Plate 1pc</p> 	<p>10157-Upper Steering Plate</p> 	<p>10004-Fuel tank Set 1set</p> 	<p>10158-Fuel Line 2pcs</p> 
<p>10159-Front/Rear Chassis Brace</p> 	<p>10160-Receiver Box 1set</p> 	<p>85026-Switch Cover 2pcs</p> 	<p>10161-Servo Horns</p> 

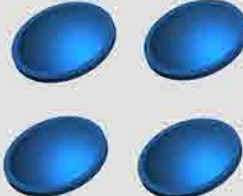
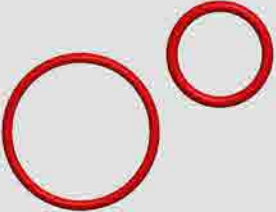
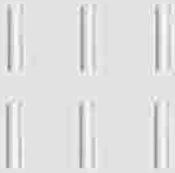



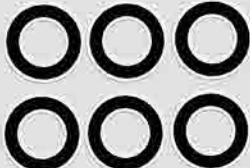



















Part List

<p>10181-Two Speed Shaft 1pc</p> 	<p>10163-Stopper 6pcs</p> 	<p>10164-Throttle Linkage 1set</p> 	<p>10165-Central Dongbone F. 1pc</p> 
<p>P0010-GO. 18 engine 1pc P0011-SH. 18 Engine 1pc</p> 	<p>10167-Air filter 1Set</p> 	<p>10168-Tuned Pipe 1Set</p> 	<p>10169-Silicone Coupler 1Set</p> 
<p>10180-Two Speed Clutch 1Set</p> 	<p>10170-Manifold 1Set</p> 	<p>85035-Flywheel 1pc</p> 	<p>85087-Clutch Nut 2pcs</p> 
<p>85045-Clutch Shoes & Springs</p> 	<p>10173-Engine mount 2pcs</p> 	<p>10331-Clutch Bell (16T) 1pc</p> 	<p>10322-Clutch Bell (21T) 1pc</p> 
<p>10005-Central Transmission Complete 1Set (Single Speed)</p> 	<p>10174-Central Transmission Bulkheads 2pcs</p> 	<p>10175-Brake Post 1Set</p> 	<p>10176-Brake Set 1set</p> 
<p>10177-Brake Cup 2pcs</p> 	<p>10178-Single Speed Shaft w/pin</p> 	<p>10179-50T Gear (Single Speed) 1pc</p> 	<p>10006-Central Transmission Complete 1Set (Two Speed)</p> 

Part List

<p>10182-50T Two Speed Gear 1pc</p> 	<p>10183-45T Two Speed Gear 1pc</p> 	<p>10324-Sway Bar 2Sets</p> 	<p>10215-Servo Link Ball End 6pcs</p> 
<p>10216-Steering Linkage Ball End 6pcs</p> 	<p>10217-Rear Upper Linkage Ball End 6pcs</p> 	<p>10218-Sway Bar Fix Plate 6pcs</p> 	<p>10219-Sway Bar Holders 6pcs</p> 
<p>10220-Ball A 6pcs</p> 	<p>10221-Ball B 6pcs</p> 	<p>10222-Ball C 6pcs</p> 	<p>10223-Ball D 6pcs</p> 
<p>10224-Shock O-ring(Lower) 6pcs</p> 	<p>10225-Diff O-ring Seal 6pcs</p> 	<p>10226-Shock Seal Cover 4pcs</p> 	<p>10227-Tuned Pipe Seal & Fuel Tank Seal 1set</p> 
<p>10228-Pin: $\phi 2 \times 10$ 6pcs</p> 	<p>10229-Pin: $\phi 2 \times 11$ 6pcs</p> 	<p>10329-Hinge Pins(long & short) 1sets</p> 	<p>10231-One Way Bearing 3pcs</p> 
<p>10232-Ball Bearing 15*10*4 6pcs</p> 	<p>10233-Ball Bearing 10*5*4 6pcs</p> 	<p>10235-Ball Bearing 8*5*2.5 6pcs</p> 	





Part List

<p>85034-Body Clip(Medium Size) 6pcs</p> 	<p>85029-Body Clip(Small Size) 6pcs</p> 	<p>10214-Shock Ball-End 6pcs</p> 	<p>RH5102-Nylon Lock Nut M3 6pc</p> 
<p>RH5103-Nylon Lock Nut-M4 6pc</p> 	<p>85148-Round Head Self Tapping Hex Screw 2*6 4pcs</p> 	<p>10238-Round Head Self Tapping Hex Screw 2*10 6pc</p> 	<p>85179-Round Head Self Tapping Hex Screw 3*15 8pc</p> 
<p>10239-Round Head Self Tapping Hex Screw M3*6 6pc</p> 	<p>10240-Button Head Hex Screw M3*8 6pc</p> 	<p>10241-Button Head Hex Screw M3*10 6pc</p> 	<p>85184-Button Head Hex Screw M3*12 6pc</p> 
<p>10242-Button Head Hex Screw M3*14 6pc</p> 	<p>85144-Ring Self Tapping Screw 3*4 4pc 10256-Ring Self Tapping Screw 3*6 6pc</p> 	<p>RH5116-Set Screw M3*3 6pc</p> 	<p>RH5117-Set Screw M4*4 6pc</p> 
<p>RH5118-Button Head Hex Screw M4*10 6pc</p> 	<p>RH5562-Cap Head Hex Screw M3*8 6pc</p> 	<p>10243-Cap Head Hex Screw M3*10 6pc</p> 	<p>85182-Cap Head Hex Screw M3*10 6pc</p> 
<p>10244-Cap Head Hex Screw M3*14 6pc</p> 	<p>85118-Cap Head Hex Screw M3*15 6pc</p> 	<p>10245-Cap Head Hex Screw M3*18 6pc</p> 	<p>85185-Cap Head Hex Screw M3*25 6pc</p> 

Part List

<p>10236-E clip-8mm 4pc</p> 	<p>RH5190-E clip-4mm 6pc</p> 	<p>10237-E clip-2.5mm 6pc</p> 	<p>10248-Flat Head Hex Screw M3*12 6p</p> 
<p>10249-Flat Head Hex Screw M3*14 6p</p> 	<p>85127-Flat Head Hex Screw M3*18 3p</p> 	<p>10250-Flat Head Hex Screw M3*20 6p</p> 	<p>10251-Flat Head Hex Screw M3*36 6p</p> 
<p>10246-Cap Head Hex Screw M3*28 6p</p> 	<p>10247-Flat Head Hex M3*8 6pc</p> 	<p>85125-Flat Head Hex Screw M3*10 8p</p> 	<p>H0049 - 3kg/cm Servo 1pc</p> 
<p>H0080-2.4GHz 3CH Transmitter 1pc</p> 	<p>H0012 - Battery Case 1pc RH5189 - Receiver Switch 1pc</p> 	<p>R0075-Buggy Tail Wing (Black) 1pc R0076-Buggy Tail Wing (Brown) 1pc R0077-Buggy Clear Tail Wing 1pc R0085-Buggy Tail Wing (Blue) 1pc R0091-Buggy Tail Wing (Red) 1pc R****-Buggy Tail Wing (Orange) 1pc</p> 	<p>R0068- Clear Body (GP) 1pc</p> 
<p>R0070- Printed Body (Black/Red) 1pc R0071- Printed Body (pink) 1pc R0080- Printed Body (Blue) 1pc</p> 	<p>10352-SC truck rim 2pcs</p> 	<p>10350-SC truck wheel complete 2sets</p> 	<p>10351-SC truck tyre & insert 2sets</p> 
<p>R0088- Clear Body 1pc</p> 	<p>R0089- Printed Body (Black) 1pc R0090- Printed Body (Red) 1pc</p> 	<p>R0110- Printed Body 1pc</p> 	<p>10260 - Body Post 2pc</p> 

Upgrade Parts List

<p>10961 - Front Shock Plate (Carbon) 1Set</p> 	<p>10962 - Rear Shock Plate (Carbon) 1Set</p> 	<p>10927-Front Lower Susp. Arm (AL) 2pc</p> 	<p>10928-Rear Lower Susp. Arm (AL) 2pc</p> 
<p>10907-Front Shocks (AL) 2pc</p> 	<p>10908-Rear Shocks (AL) 2pc</p> 	<p>10911 - Steering Ackerman (AL) 1pc</p> 	<p>10912 - Front Susp. Holders (AL) 1Set</p> 
<p>10913 - Front & Rear Brace (AL) 1Set</p> 	<p>10914 - Rear Susp. Holders (AL) 1Set</p> 	<p>10915 - Rear Hub Carrier (AL) 2pc</p> 	<p>10916-Front Top Plate (Carbon) 1pc</p> 
<p>10917 - Steering Knuckle Arm (AL) 2Set</p> 	<p>10918 - Wheel Hub (AL) 4pc</p> 	<p>10919 - Upper Plate (AL) 1pc</p> 	<p>10920 - Tuned Pipe (AL) 1Set</p> 
<p>10921 - Chassis Brace mount (AL) 1pc</p> 	<p>10960-Rear CVA drive Shaft 1set</p> 	<p>10923 - Alum Steering Arm 2pc</p> 	<p>10924 - Alum Knuckle Arm 2pc</p> 