

**1:10TH XL READY-TO-RUN
4WD TRAIL VEHICLE**

KANYON



FRANÇAIS INSTRUCTIONS – PAGE 11
DEUTSCH INSTRUCTIONS – PAGE 20

INSTRUCTION BOOK AND COMPONENT LISTING



www.ftx-rc.com





Shocks (Bag A)

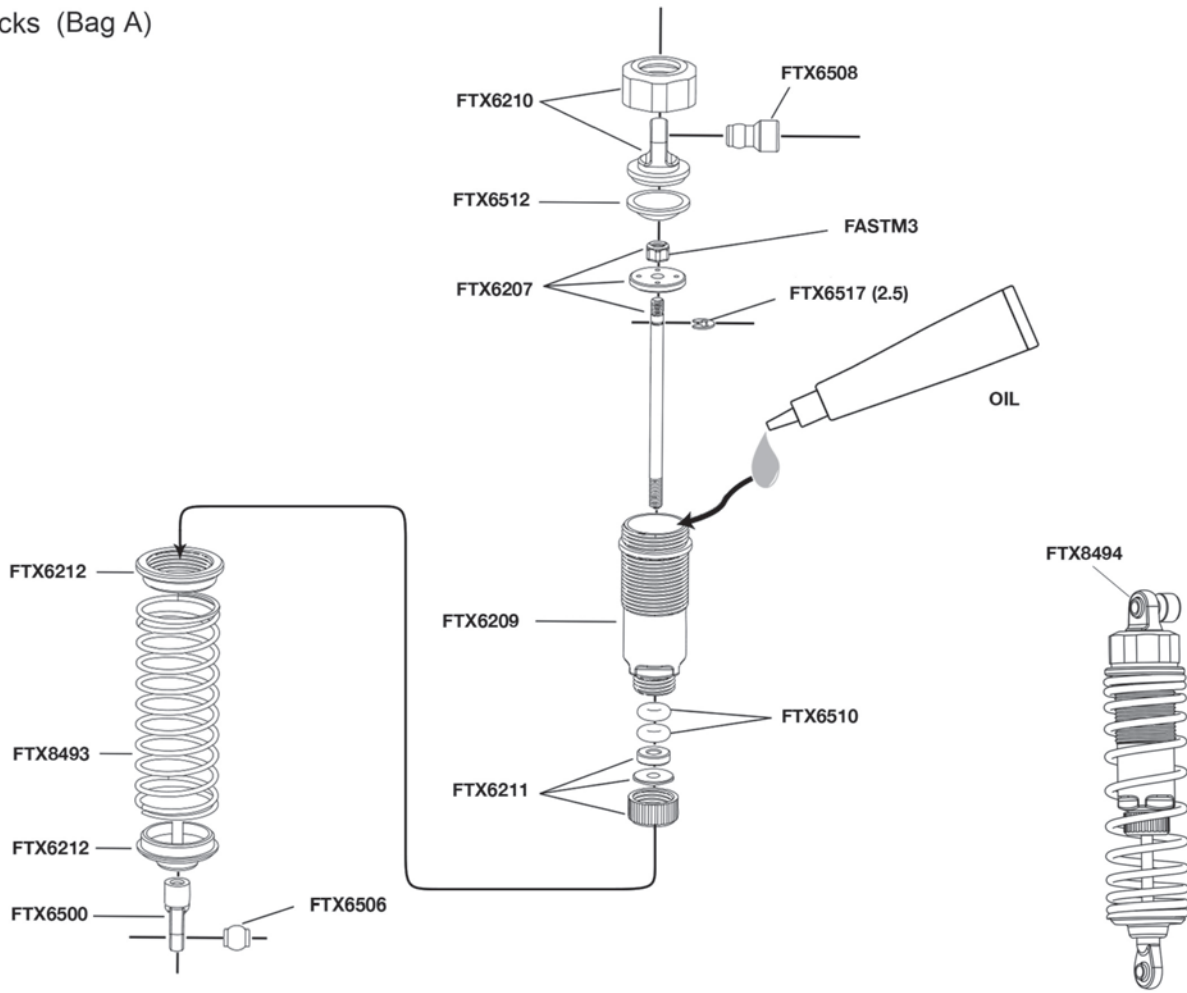

Front/Rear Gearbox (Bag B)

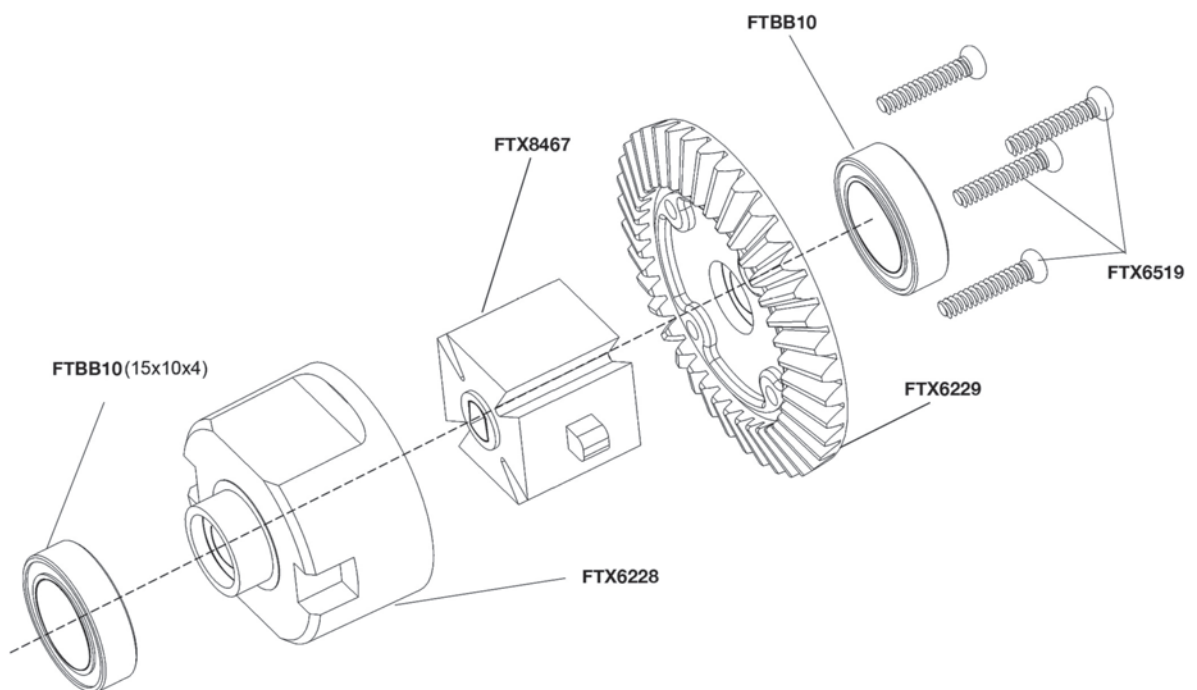

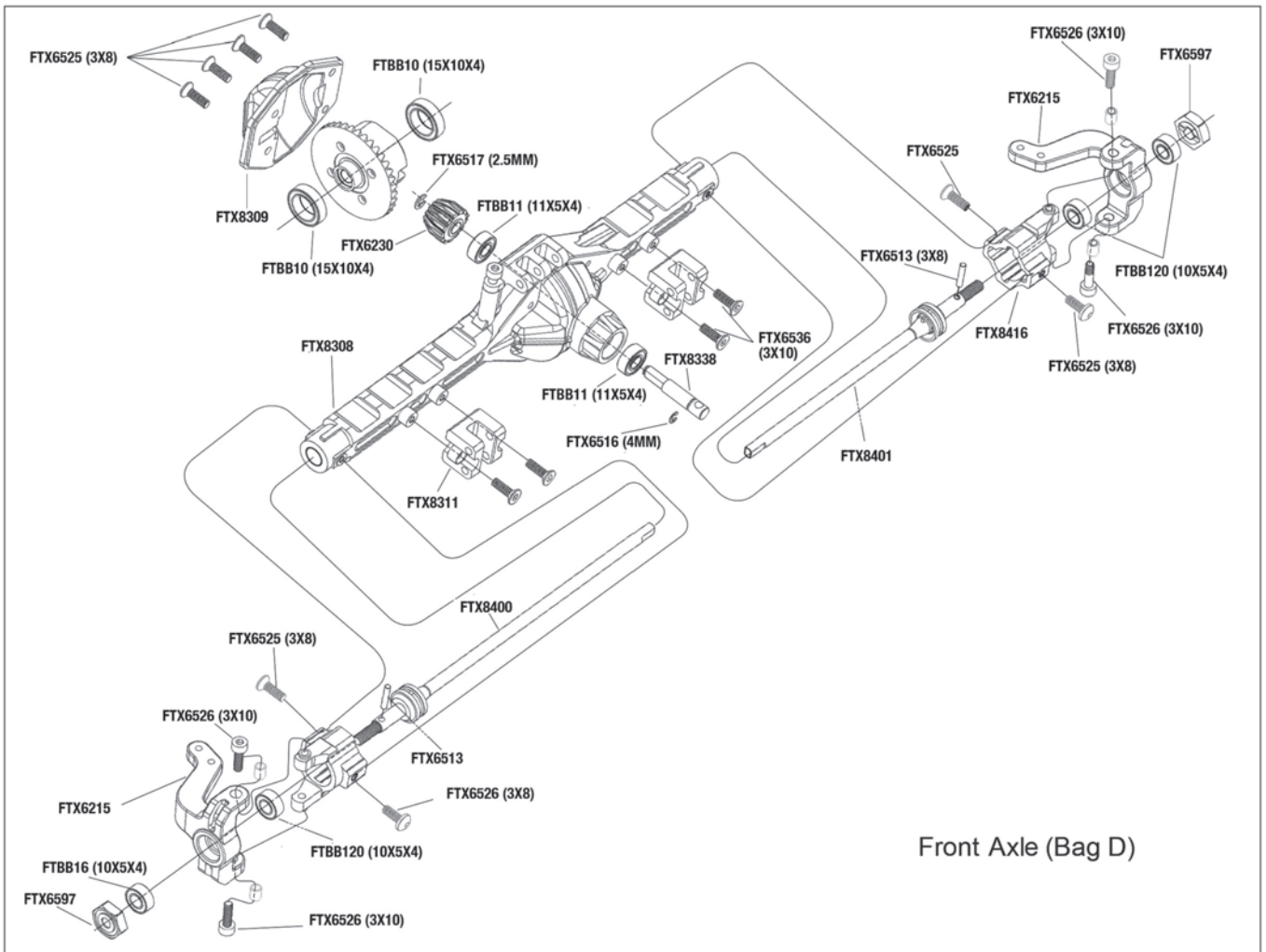
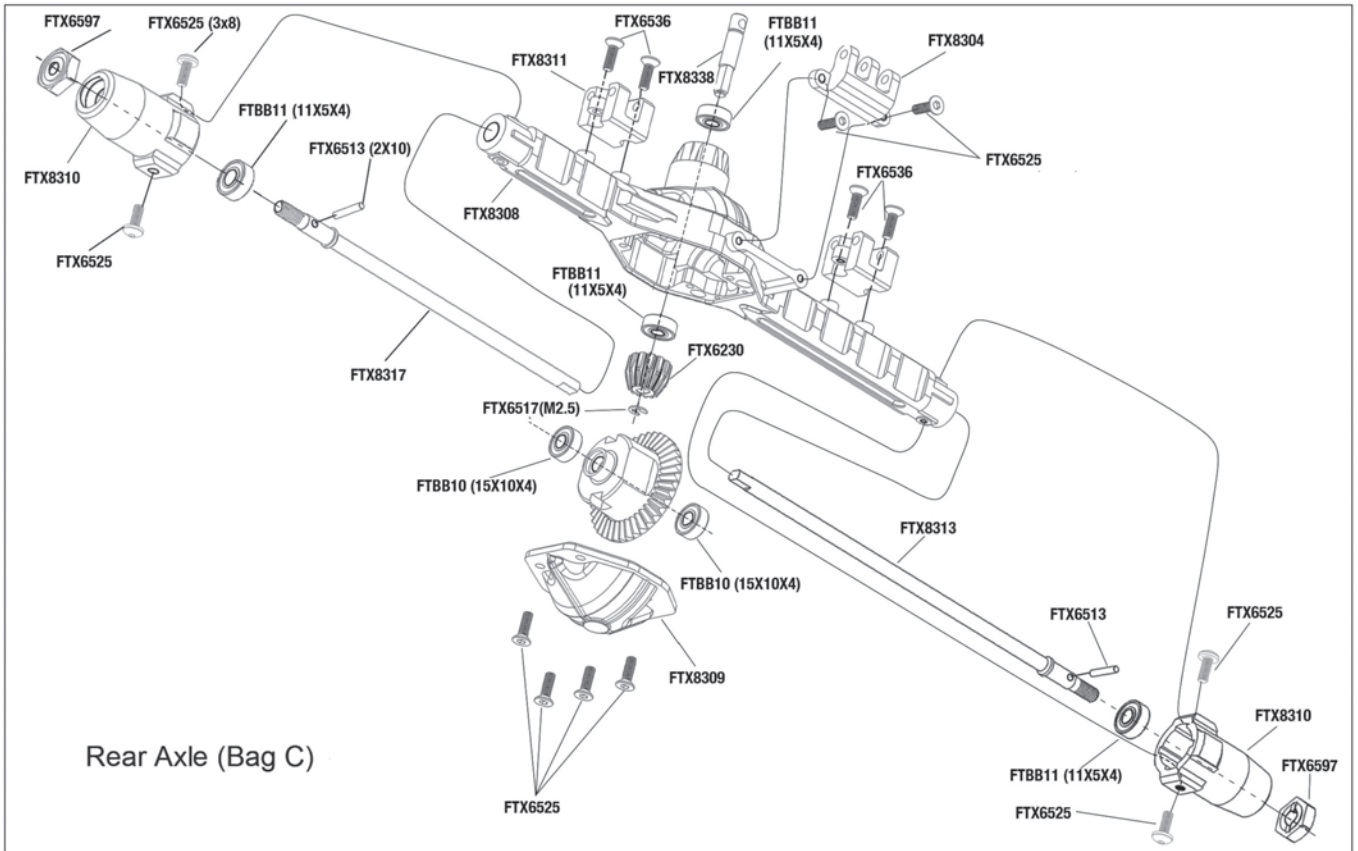



Parts Diagram

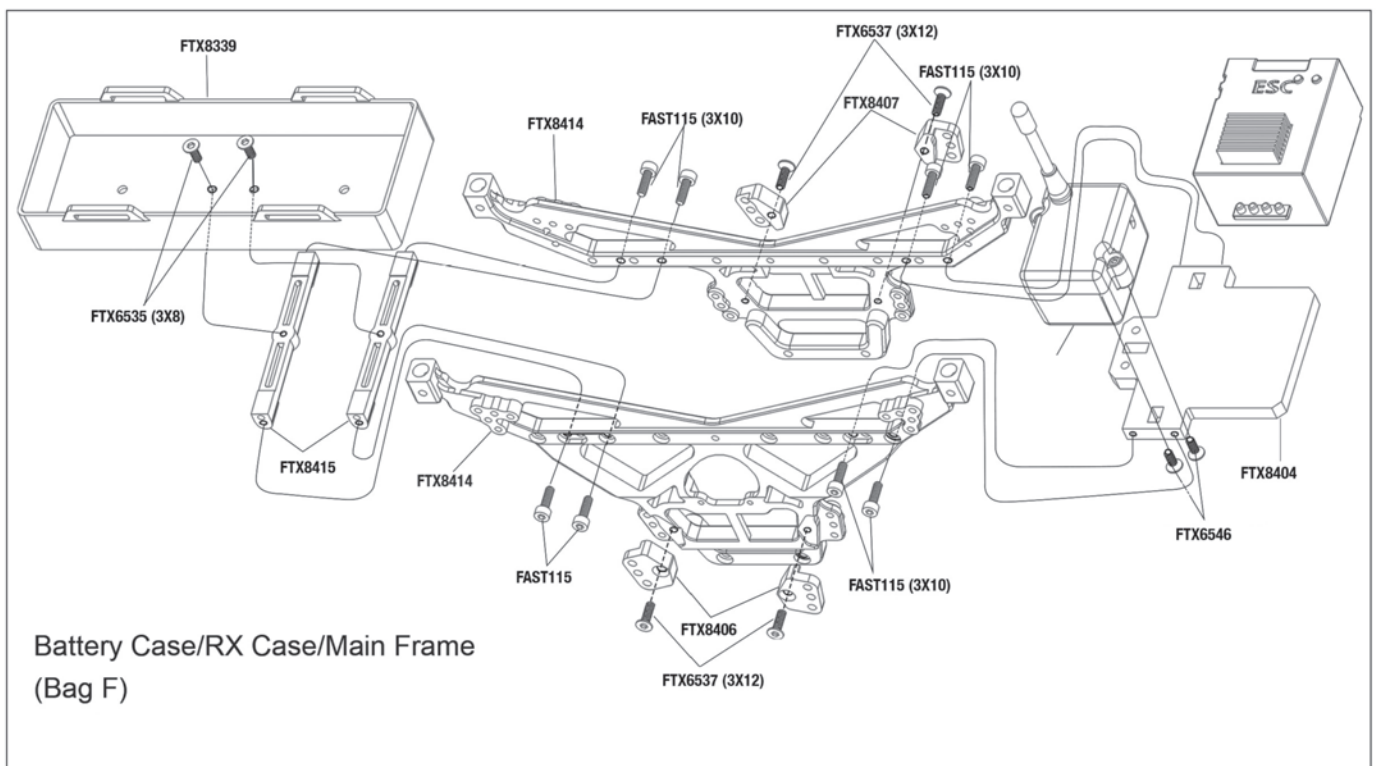
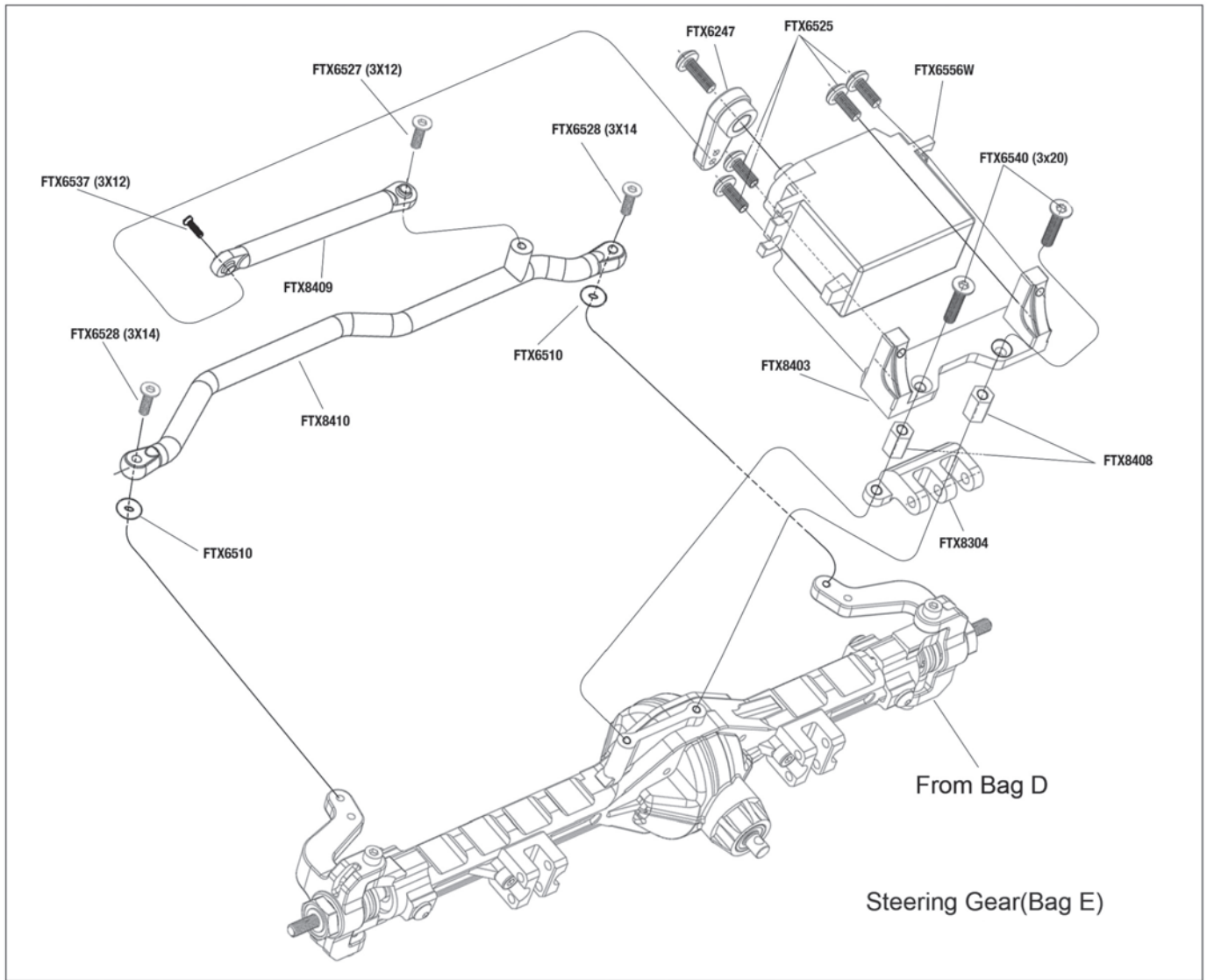



Parts Diagram

Body Bracket (Bag G)

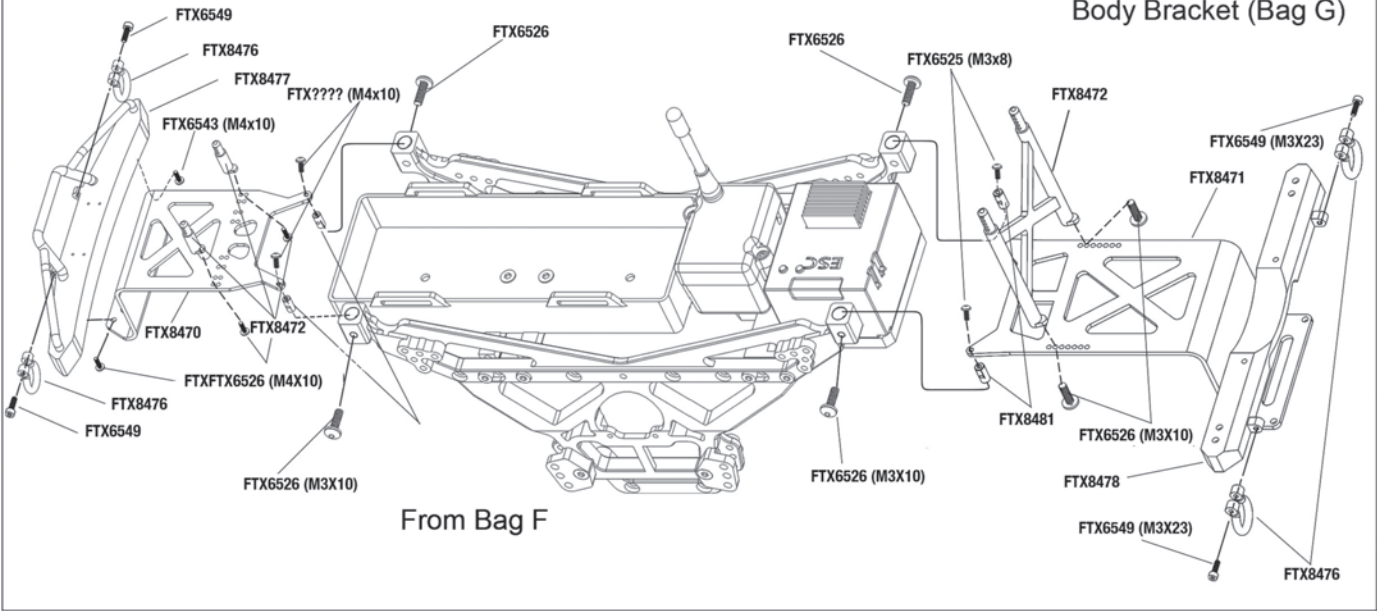

Linkages (Bag H)

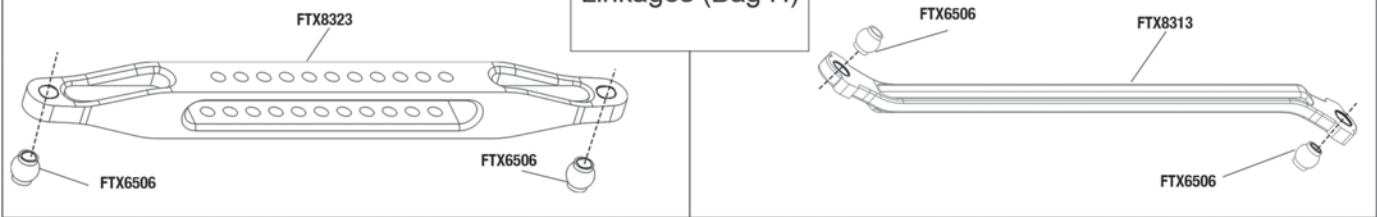

Central Diff Lock to replace (Bag I) the diff gears

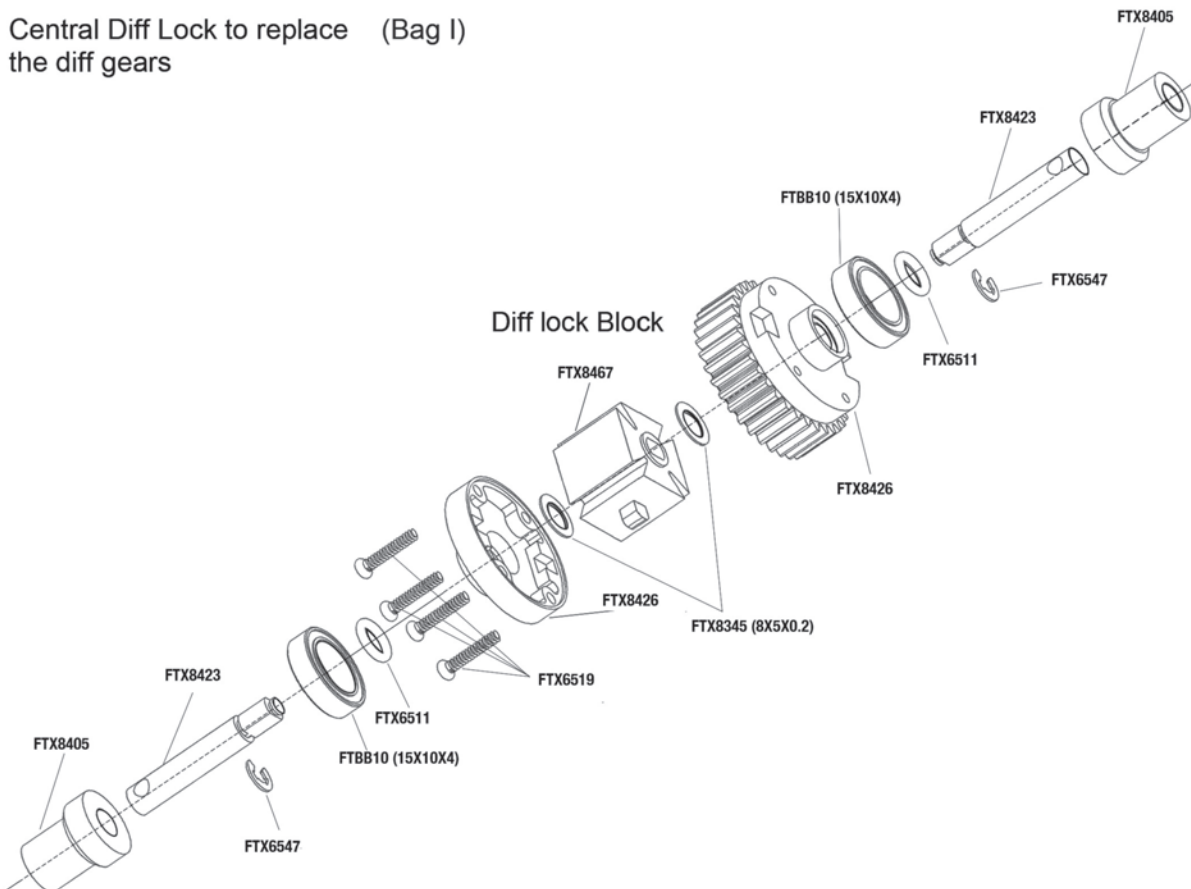



Centra Transmission I (Bag J)

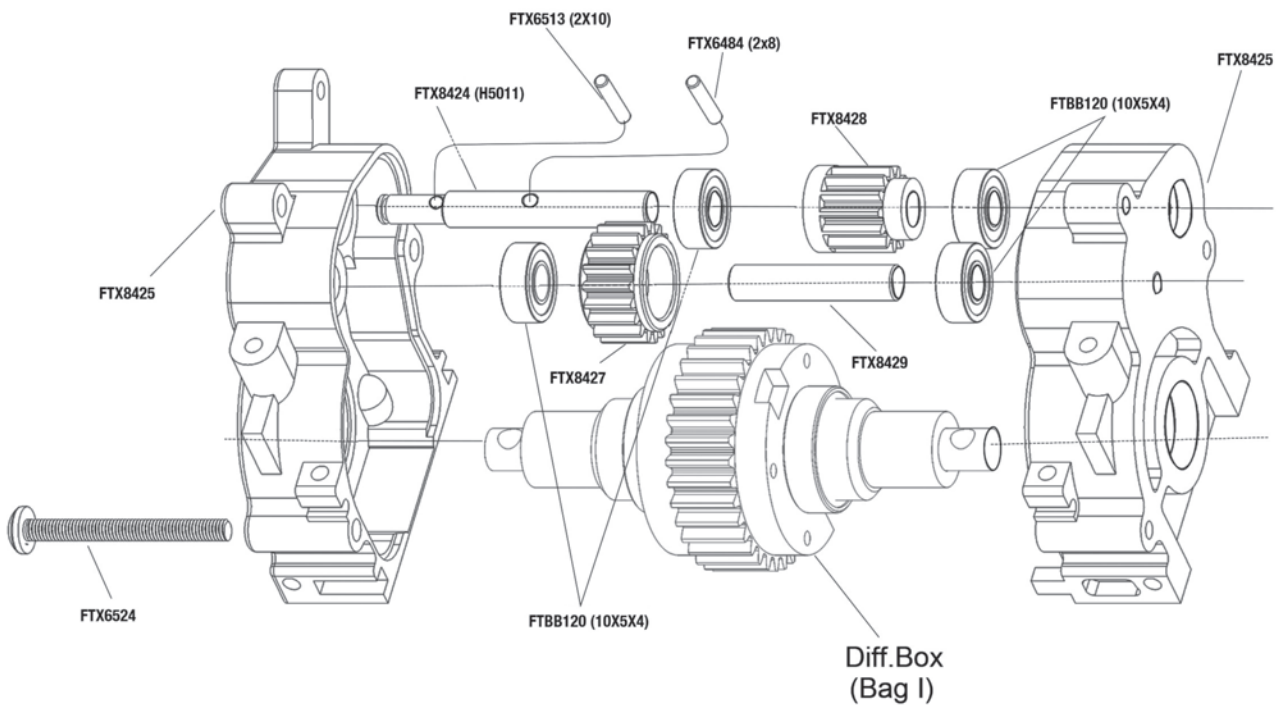

Motor Assembly (Bag K)

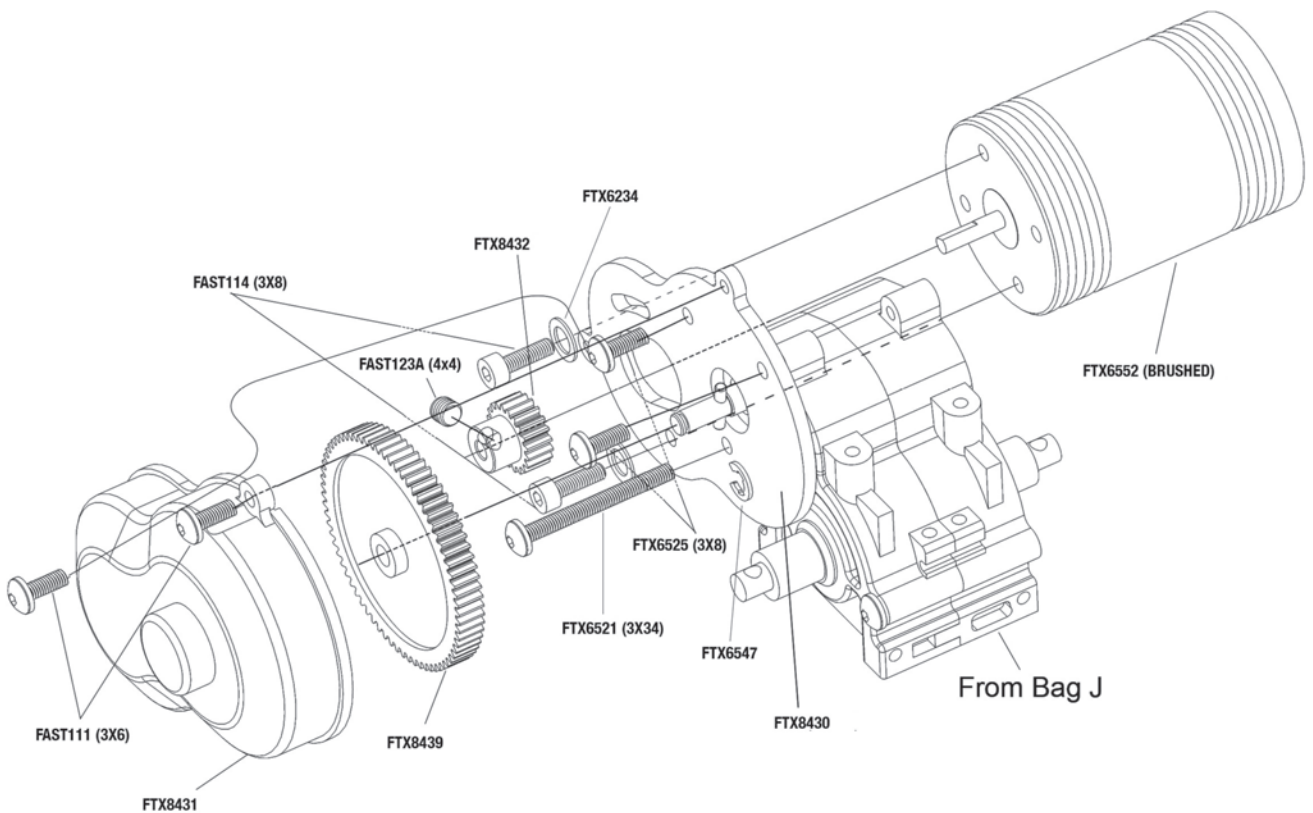



Central Transmission II (Bag L)

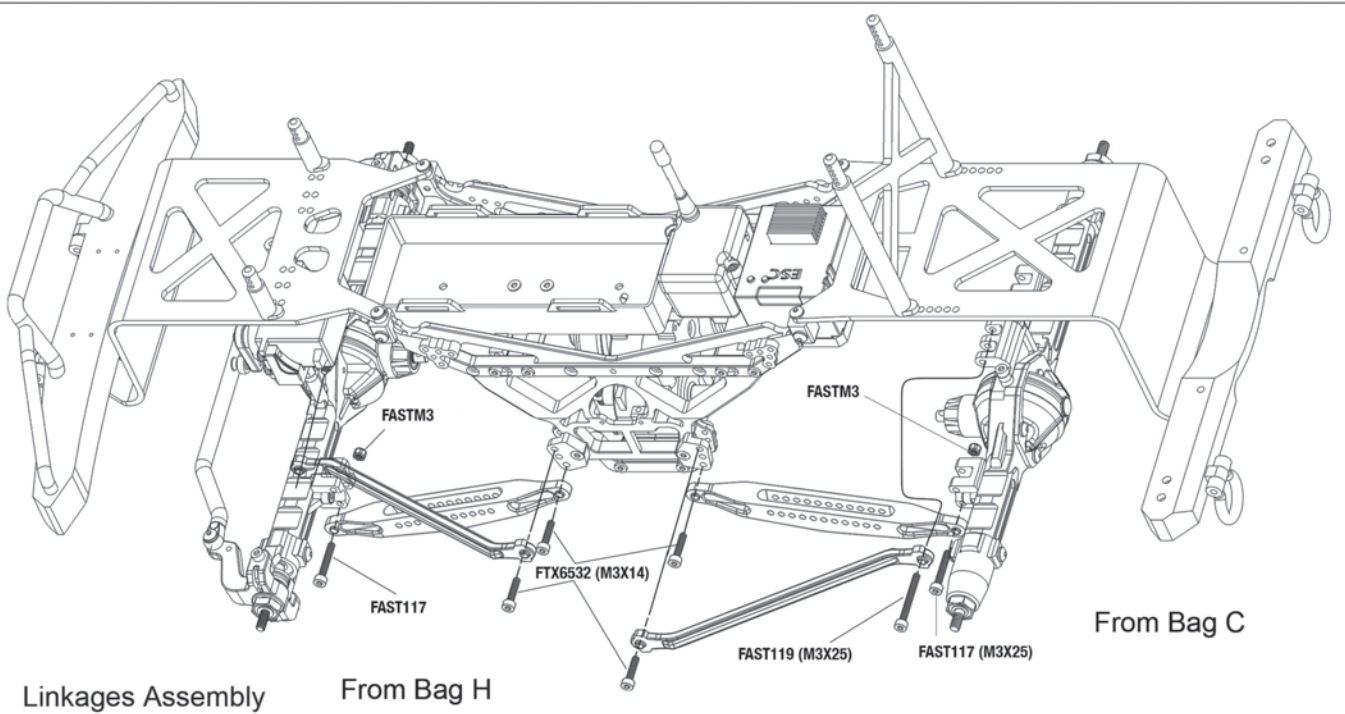
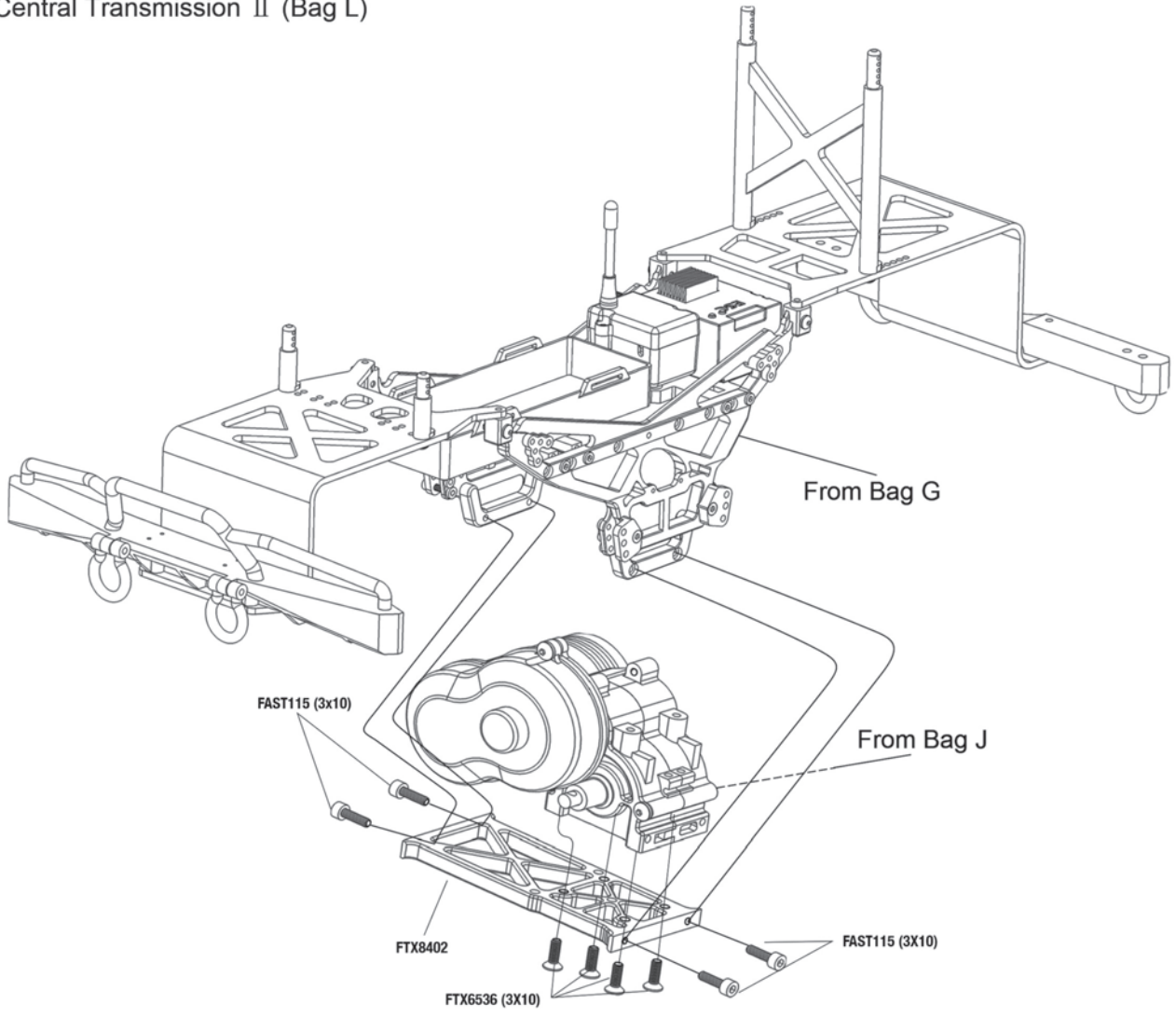

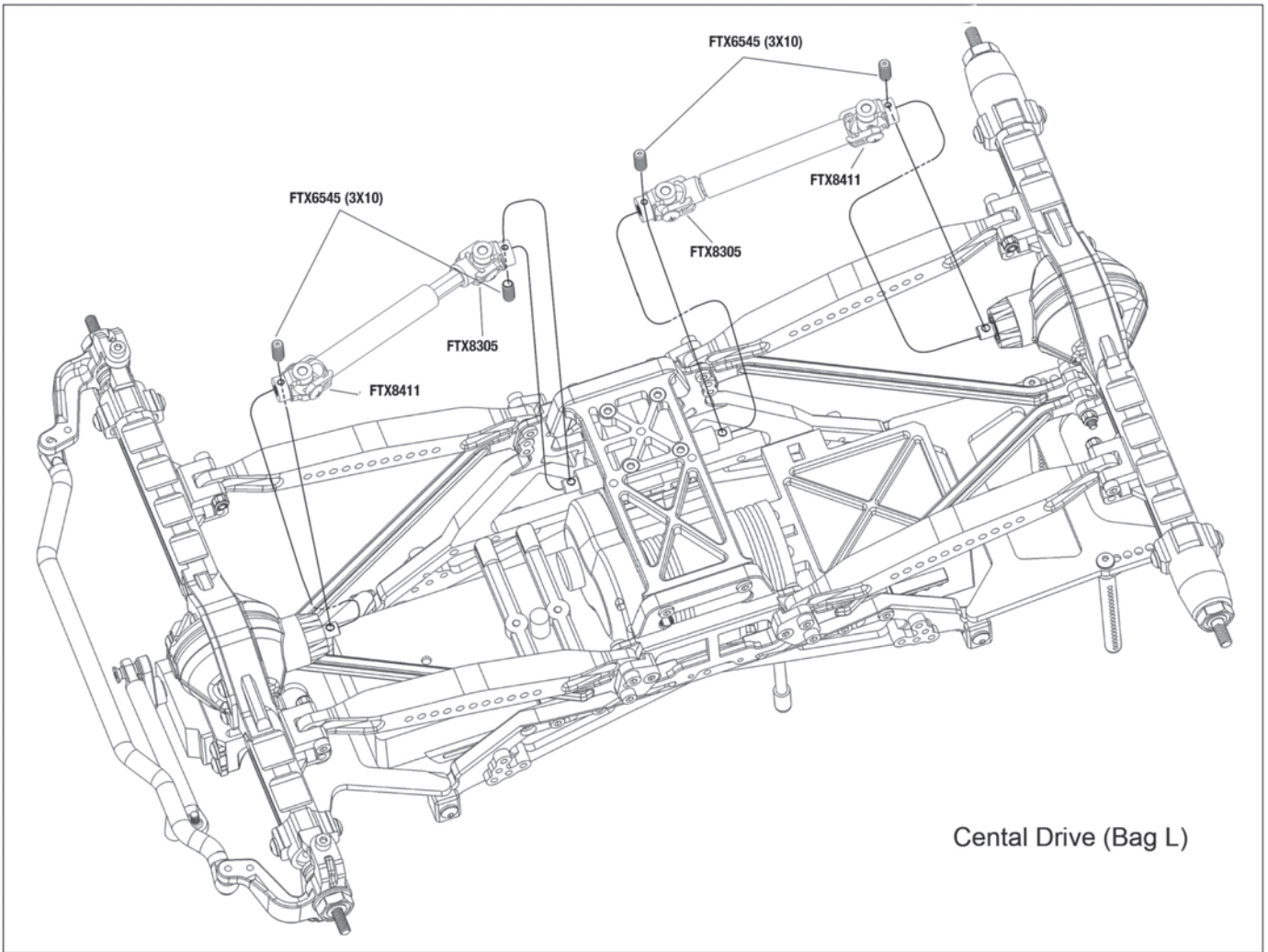

Shocks Assembly

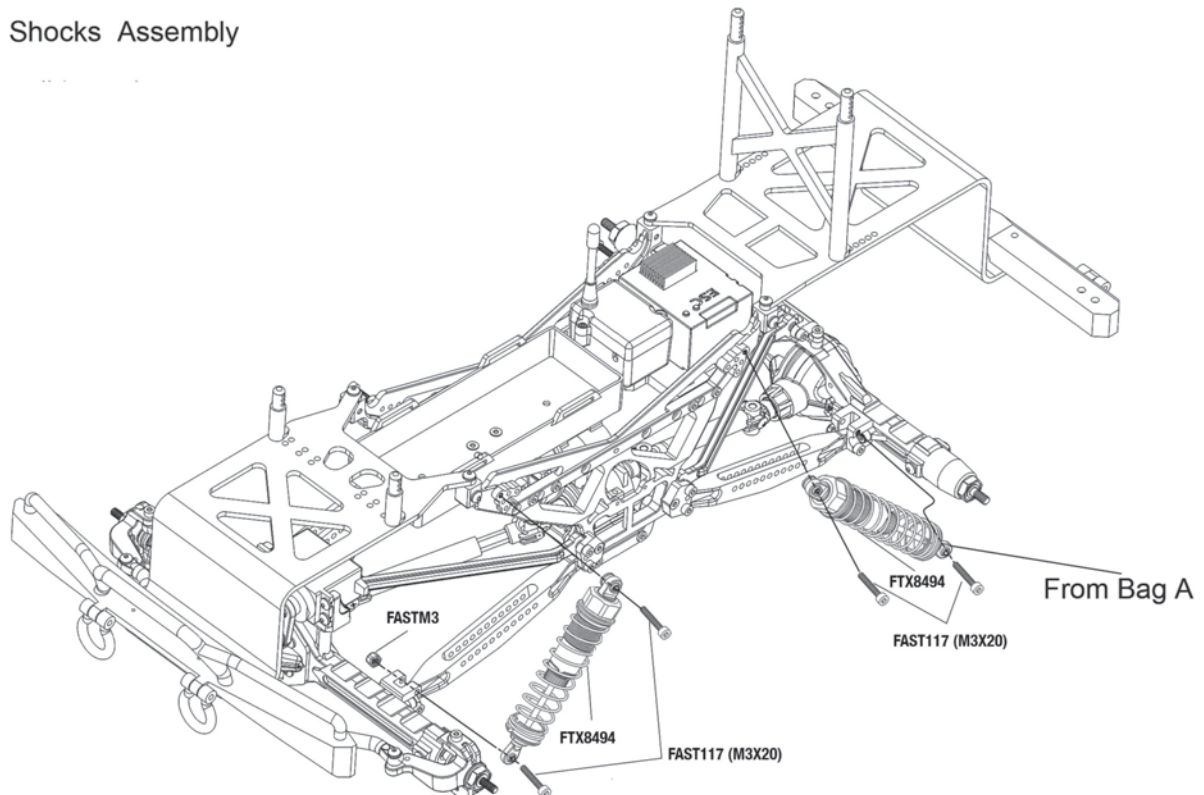



Parts Diagram

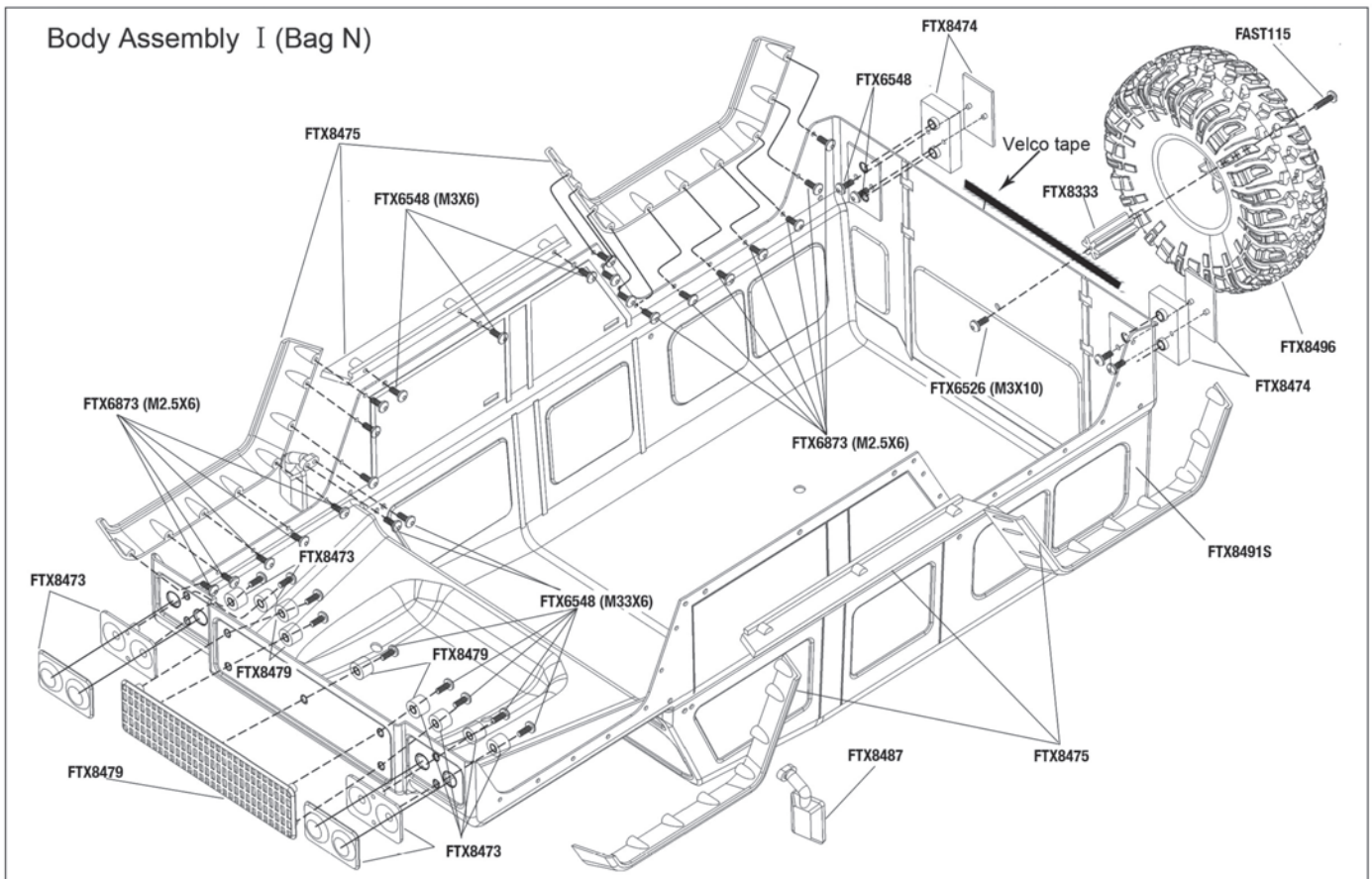
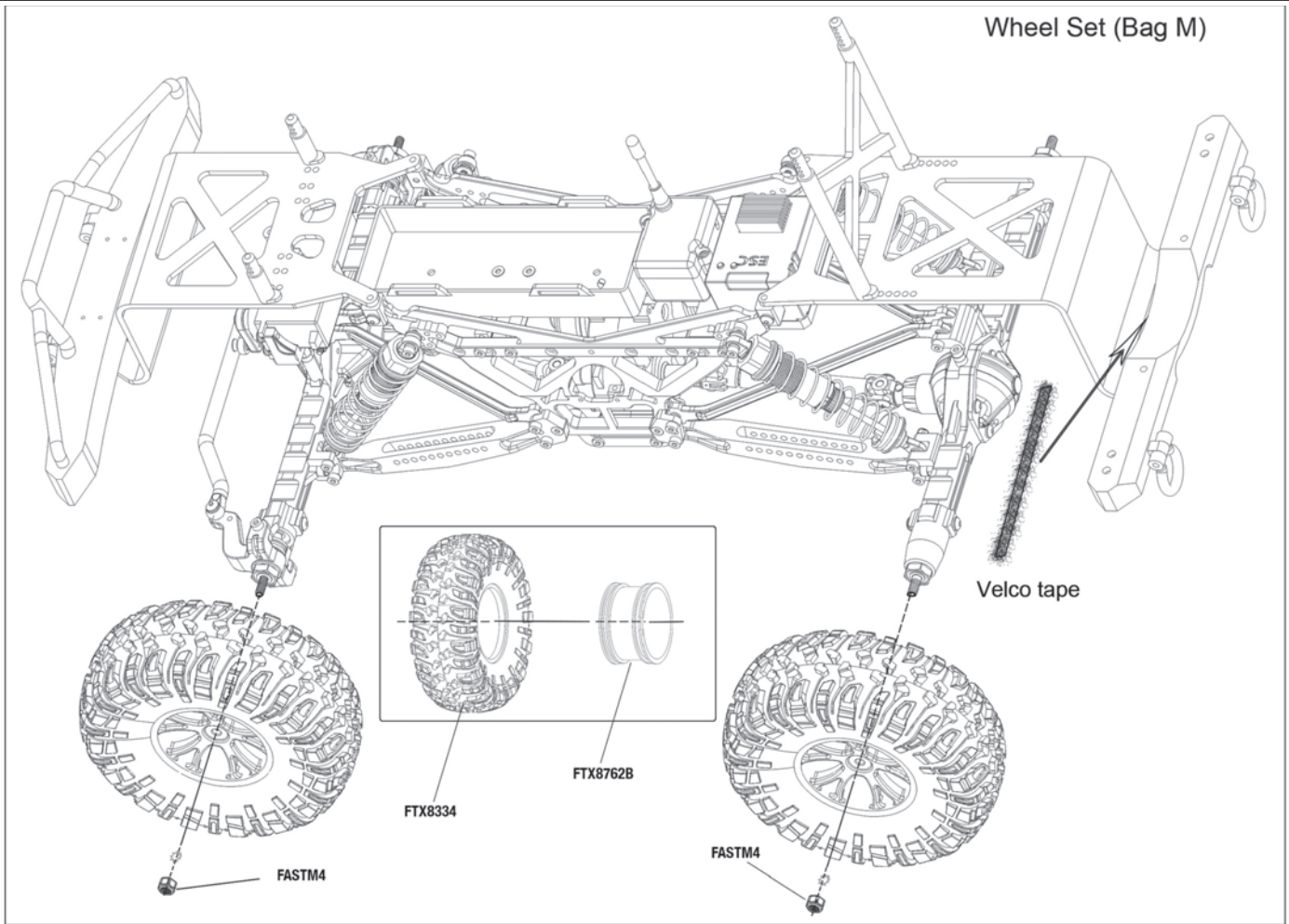



Roll Cage Assembly (Bag O)

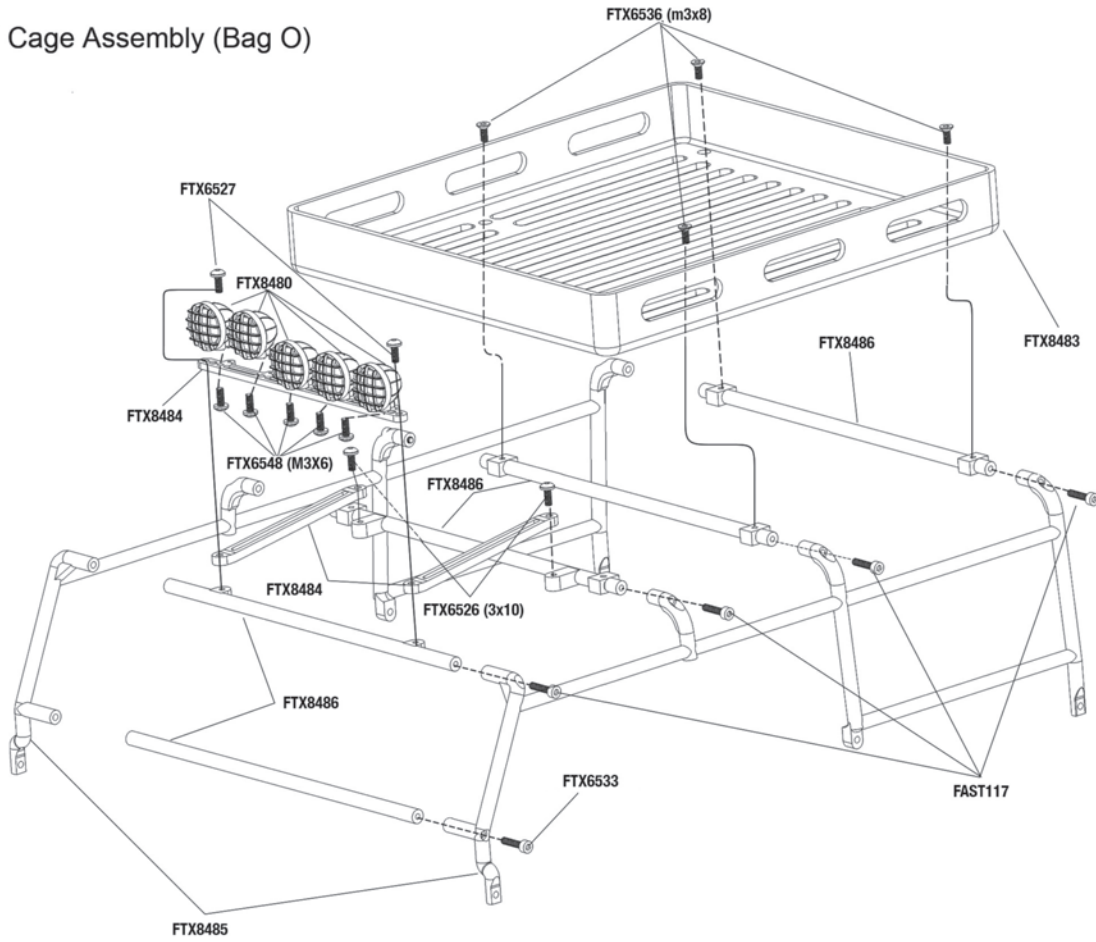

Body Assembly I (Bag P)

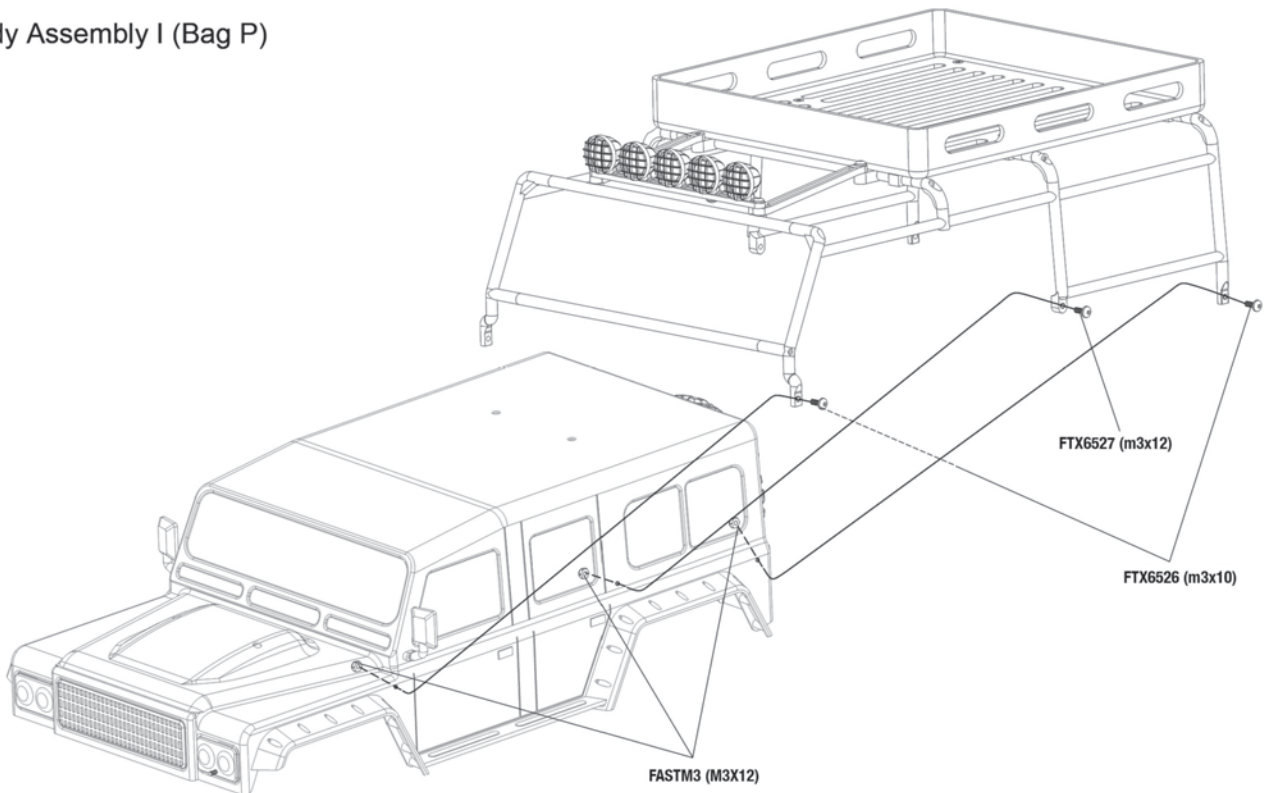



Body Assembly II

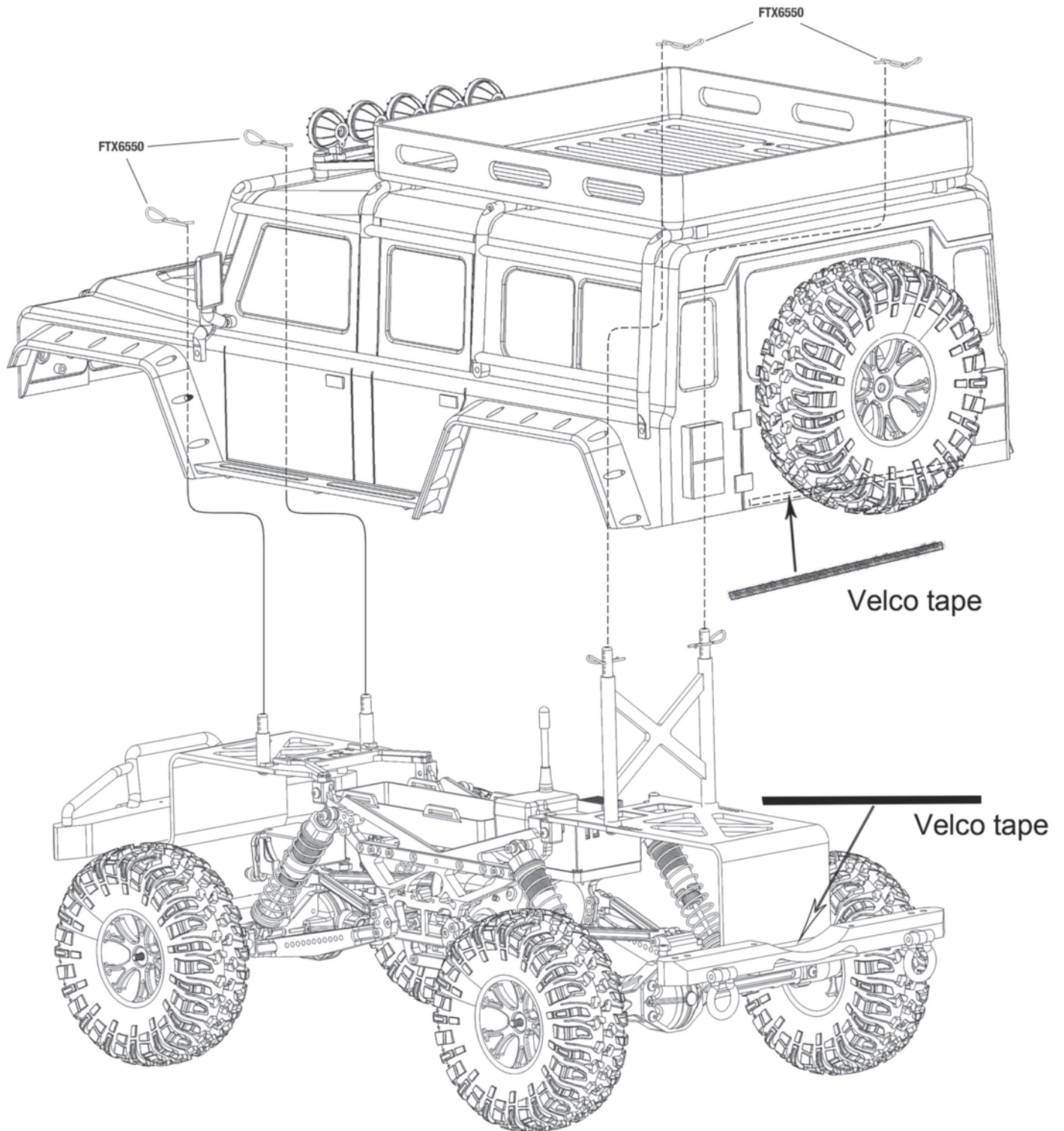



PARTS LIST

<p>FTX8400 – CVD Long. 2 pcs</p> 	<p>FTX8401 – CVD Short. 2 pcs</p> 	<p>FTX8402 – Chassis Plate. 1 pc</p> 	<p>FTX8403 – Servo Mount. 1 pc</p> 
<p>FTX8404 – ESC Bracket. 1 pc</p> 	<p>FTX8405 – Drive Coupler. 2 pcs</p> 	<p>FTX8406 – Support Rod Holder L. 2 pcs</p> 	<p>FTX8407 – Support Rod Holder R. 2 pcs</p> 
<p>FTX8408 – Servo Mount Post. 2 pcs</p> 	<p>FTX8409 – Steering Rod S. 1 pc</p> 	<p>FTX8410 – Steering Rod L. 1 pc</p> 	<p>FTX6215 – Steering Knuckle Arm. 2 sets</p> 
<p>FTX8414 – Main Frame. 2 pcs</p> 	<p>FTX8415 – Battery Case Holder. 2 pcs</p> 	<p>FTX8416 – Steering Knuckle. 2 pcs</p> 	<p>FTX8422 – Roll Cage Spacer. 4 pcs</p> 
<p>FTX8423 – Central Diff. Shaft. 1 pc</p> 	<p>FTX8334 – Tyres & Foam inserts. 2 pcs</p> 	<p>FTX8496 – Preassembled Tyres. 2 sets</p> 	<p>FTX8762B – Rim. 2 pcs</p> 
<p>FTX8313 – Front/Rear Link Set. 2 pcs</p> 	<p>FTX8323 – Front/Rear Shocks Lower Support Rod. 2 pcs</p> 	<p>FTX6547 – E-Clip - 3mm. 6 pcs</p> 	<p>FTX8439 – Spur Gear. 1 pc</p> 



PARTS LIST

<p>FTX8304 – Rear Link Holder. 1 pc</p> 	<p>FTX6484 – Pin (8 x 2),10 pcs</p> 	<p>FTX8308 – Front/Rear Axle Housing. 1 pc</p> 	<p>FTX8309 – Front/Rear Axle Cover. 1 pc</p> 
<p>FTX8310 – Axle Adaptor. 2 pcs</p> 	<p>FTX8311 – Holder for Shock Support Rod. 2 pcs</p> 	<p>FTX8494 – Front & Rear Shocks. 2 pcs</p> 	<p>FTX8338 – Rear Diff. Shaft. 1 pc</p> 
<p>FTX6207 – Front/Rear Shock Shaft & Piston Set. 2 sets</p> 	<p>FTX6209 – Front/Rear Shock Body. 2 pcs</p> 	<p>FTX6210 – Upper Shock Cap. 2 sets</p> 	<p>FTX6211 – Lower Shock Cap. 2 sets</p> 
<p>FTX6212 – Lower Shock Holder & Adjust Ring. 2 sets</p> 	<p>FTX6228 – Diff. Case. 2 pcs</p> 	<p>FTX6229 – Diff. Drive Spur Gear. 2 pcs</p> 	<p>FTX6230 – Diff. Drive Gear. 2 pcs</p> 
<p>FTX8317 – Rear Short Driveshaft. 1 pc</p> 	<p>FTX8318 – Rear Short Driveshaft. 1 pc</p> 	<p>FTX8313 – Axle Housing to Chassis Link Set. 2 pcs</p> 	<p>FTX6234 – Washer. 6 pcs</p> 
<p>FTX6597 – Wheel Hub. 4 pcs</p> 	<p>FAST103B – Antenna Pipe Set. 2 sets</p> 	<p>FTX8424 – Slipper Shaft (EBD). 1 pc</p> 	<p>FTX6550 – Body Clip (medium Size). 6 pcs</p> 





















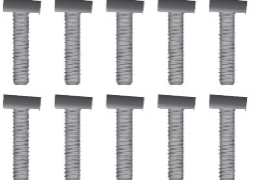



PARTS LIST

<p>FTX6335 – Pinion gear 17T. 1 pc</p> 	<p>FTX8425 – Gearbox Housing Set. 2 pcs</p> 	<p>FTX8426 – 19T Gear. 1 pc</p> 	<p>FTX8427 – 19T Gear. 1 pc</p> 
<p>FTX8428 – 13T Gear. 2pcs</p> 	<p>FTX8429 – Gear Shaft, 1 pc</p> 	<p>FTX8430 – Motor Mount, 1 pc</p> 	<p>FTX8431 – Gear Cover, 1 pc</p> 
<p>FTX8432 – Pinion Gear 15T. 1 pc</p> 	<p>FTX6247 – Servo Horns. 2 pcs</p> 	<p>FASTM3 – Nyloc Nut-M3. 6 pcs</p> 	<p>FASTM4 – Nyloc Nut-M4. 6 pcs</p> 
<p>FTX8339 – Battery Case. 1 pc</p> 	<p>FTX8346 – Velcro Tape. 2 pcs</p> 	<p>FTX8490 – Clear Body only. 1 pc</p> 	<p>FTX8491S – Painted Body only. 1 pc</p> 
<p>FTX6500 – Shock Ball End. 6 pcs</p> 	<p>FTX6501 – Servo Link Ball End. 6 pcs</p> 	<p>FTX6502 – Steering Linkage Ball End. 6 pcs</p> 	<p>FTBB11 – Ball Bearing (11x5x4mm). 1 pc</p> 
<p>FTX8342 – Pin 2x13. 6 pcs</p> 	<p>FTX8345 – Washer (8x5x0.2mm). 6 pcs</p> 	<p>FTX6875 – Button Head Hex Screw M2.5x10. 6 pcs</p> 	<p>FTX6516 – E-Clip-4mm. 6 pcs</p> 



























PARTS LIST

<p>FTX6517 – E-Clip-2.5mm. 6 pcs</p> 	<p>FTX6506 – Ball A. 6 pcs</p> 	<p>FTX6507 – Ball B. 6 pcs</p> 	<p>FTX6508 – Ball C. 6 pcs</p> 
<p>FTX6510 – Shock O-Ring (Lower). 6 pcs</p> 	<p>FTX6511 – Diff. O-Ring Seal. 6 pcs</p> 	<p>FTX6512 – Shock Seal Cover. 4 pcs</p> 	<p>FTX6513 – Pin 2x10. 6 pcs</p> 
<p>FTBB10 – Ball Bearing 15x10x4. 6 pcs</p> 	<p>FTBB16 – Ball Bearing 10x5x4. 6 pcs</p> 	<p>ET0220 – Wall Charger 1000mAH (UK Plug) ET0220E – Wall Charger 1000mAH - (Euro Plug).1 pc</p> 	<p>FTX6523 – Button Head Hex Tapping Screws 3x10. 8 pcs</p> 
<p>FTX8433 – Reciever (Rx) Case. 1 set</p> 	<p>FTX6556W – 9kg Servo. 1 pc</p> 	<p>VZ0010 – Battery pack. 1 pc</p> 	<p>FTX6557W – 40A ESC. 1 pc</p> 
<p>FTX6552 – 540 Brushed Motor. 1 pc</p> 	<p>FTX8492 – LED Lights Set. 1 set</p> 	<p>FTX6545 – Screw Set-M3x10. 6 pcs</p> 	<p>FAST114 – Cap Head Hex Screw-M3x23. 6 pcs</p> 
<p>FAST123A – Screw Set-M4x4. 6 pcs</p> 	<p>FTX6549 – Cap Head Hex Screw-M3x23. 6 pcs</p> 	<p>FTX6519 – Round Head Self-Tapping Hex Screw-2x10. 6 pcs</p> 	<p>FTX6522 – Round Head Self-Tapping Hex Screw M3x6. 6 pcs</p> 





















PARTS LIST

<p>FTX6525 – Button Head Hex Screw- M3x8. 6 pcs</p> 	<p>FTX6526 – Button Head Hex Screw- M3x10. 6 pcs</p> 	<p>FTX6528 – Button Head Hex Screw- M3x14. 6 pcs</p> 	<p>FTX6542 – Cap Head Hex Screw- M3x10. 6 pcs</p> 
<p>FTX6532 – Cap Head Hex Screw- M3x14. 6 pcs</p> 	<p>FAST118 – Cap Head Hex Screw- M3x18. 6 pcs</p> 	<p>FTX6535 – Flat Head Hex-M3x8. 6 pcs</p> 	<p>FTX6537 – Flat Head Hex Screw- M3x17. 6 pcs</p> 
<p>FTX6538 – Flat Head Hex Screw- M3x14. 6 pcs</p> 	<p>FTX6540 – Flat Head Hex Screw- M3x20. 6 pcs</p> 	<p>FAST117– Cap Head Hex Screw- M3x14. 6 pcs</p> 	<p>FTX6524 – Button Head Hex Screw- M3x30. 6 pcs</p> 
<p>FTX6521 – Button Head Hex Screw- M3x34. 6 pcs</p> 	<p>FTX6548 – Umbrella Head Screw- M3x6. 6 pcs</p> 	<p>FTX6546 – Flat Head Self-Tapping Screw Set-3x10mm. 12 pcs</p> 	<p>FAST115 – Cap Head Hex Screw- M3x10. 6 pcs</p> 
<p>FTX6527 – Button Head Hex Screw- M3x12. 6 pcs</p> 	<p>FAST119 – Cap Head Hex Screw- M3x25. 6 pcs</p> 	<p>FTX6544 – Flat Head Hex-M3x6. 6 pcs</p> 	<p>FTX8470 – Front Body Bracket (Al.). 1 pc</p> 
<p>FTX8471 – Rear Body Bracket (Al.). 1 pc</p> 	<p>FTX8472 – Body posts. 1 set</p> 	<p>FTX8473 – Front Light Bracket. 1 set</p> 	<p>FTX8474 – Rear Light Bracket. 1 set</p> 











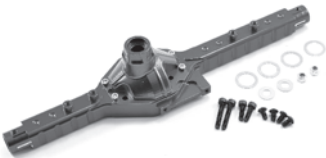
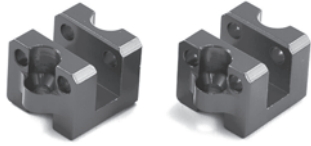
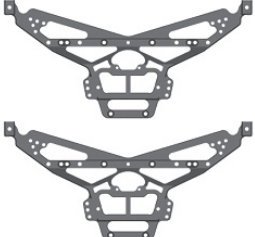

PARTS LIST

<p>FTX8475 – Mudguard & Pedal. 1 set</p> 	<p>FTX8476 – Rescue Rings. 4 pcs</p> 	<p>FTX8477 – Rear Bumper. 1 pc</p> 	<p>FTX8478 – Front Bumper. 1 pc</p> 
<p>FTX8479 – Front Exhaust Plate. 1 set</p> 	<p>FTX8480 – Head Light Bracket. 5 pcs</p> 	<p>FTX8481 – Body Bracket Post. 4 pcs</p> 	<p>FTX8482 – Roll Cage w/Light Bracket & Tray. 1 set</p> 
<p>FTX8483 – Plastic Tray. 1 pc</p> 	<p>FTX8484 – Head Light Bracket Support. 3 pcs</p> 	<p>FTX8485 – Body Side Frame. 2 pcs</p> 	<p>FTX8486 – Body Top Frames. 5 pcs</p> 
<p>FTX8487 – Door Mirrors. 2pcs</p> 	<p>FTX8488 – Clear Body w/Roll Cage, Tray & Light Bracket. 1 set</p> 	<p>FTX8489S – Painted Body w/Roll Cage, Tray & Light Bracket. 1 set</p> 	<p>FTX8493 – Rear Shock Spring. 2 pcs</p> 
<p>FTX8467 – Upgrade Diff. Locker. 1 pc</p> 	<p>FTX6536 – Flat Head Hex Screw-M3x10. 8 pcs</p> 		



UPGRADE PARTS LIST

<p>FTX8495 – Aluminium Front Shocks. 2 pcs</p> 	<p>FTX8381 – Aluminium Rear Link Holder. 1 pc</p> 	<p>FTX8383 – Aluminium Axle Adaptor. 2 pcs</p> 	<p>FTX8385 – Aluminium Rear Axle Housing. 1 pc</p> 
<p>FTX8387 – Aluminium Rear Axle. 2 pcs</p> 	<p>FTX8386 – Aluminium Holder for Rear Shock Support. 2 pcs</p> 	<p>FTX6365W – Aluminium Wheel Hub. 4 pcs</p> 	<p>FTX6367 – Aluminium Steering Arms. 2 pcs</p> 
<p>FTX8450 – Main Frame. 2 pcs</p> 	<p>FTX8451 – Aluminium Chassis Plate. 1 pc</p> 	<p>FTX8452 – Central CVD Set. 2 pcs</p> 	<p>FTX8453 – Battery Case Holder. 2 pcs</p> 
<p>FTX8454 – Aluminium Servo Mount. 1 pc</p> 	<p>FTX8455 – Aluminium ESC Bracket. 1 pc</p> 	<p>FTX8456 – Support Rod Holder L. 2 pcs</p> 	<p>FTX8457 – Support Rod Holder R. 2 pcs</p> 
<p>FTX8458 – Aluminium Steering Knuckles. 2 pcs</p> 	<p>FTX8459 – Steering Rods. 1 pc</p> 	<p>FTX8460 – Aluminium Shocks Lower Support Rod. 1 pc</p> 	<p>FTX8462 – Aluminium Rear Link Set. 2 pcs</p> 
<p>FTX8411 – Central CVD Outer Half. 1 set FTX8411S – Central CVD Outer Half w/steel Coupler. 1 set</p> 	<p>FTX8305 – Central CVD Inner Half. 1 set FTX8305S – Central CVD Inner Half w/Steel Coupler. 1 set</p> 		



Notes:

A large rectangular area with a white background and a black border, containing 25 horizontal dotted lines for writing notes.



Notes:

A large rectangular area with a white background and a thin black border, containing 25 horizontal dotted lines for writing notes.

KANYON



www.ftx-rc.com

