

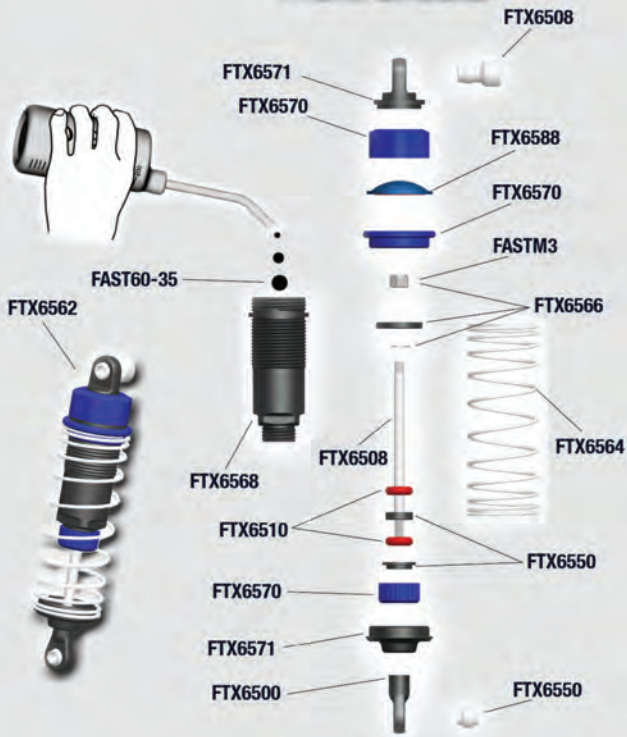

FRONT & REAR SHOCK ASSEMBLY

Front Shocks



(Dia.3-1)

Rear Shocks

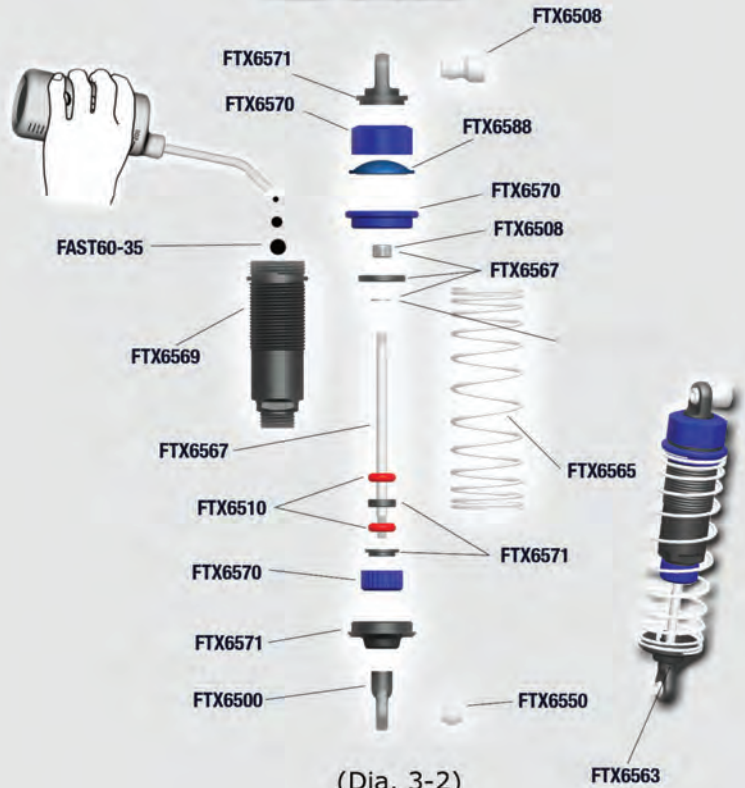

(Dia. 3-2)



Steering Servo



(Dia.3-3)

Tyres



FAST0092B

(Dia. 3-4)



Below you will see fitting instructions for the OPTIONAL front and rear anti-roll bars that are available for your drift or touring car.

Part number: FTX6487

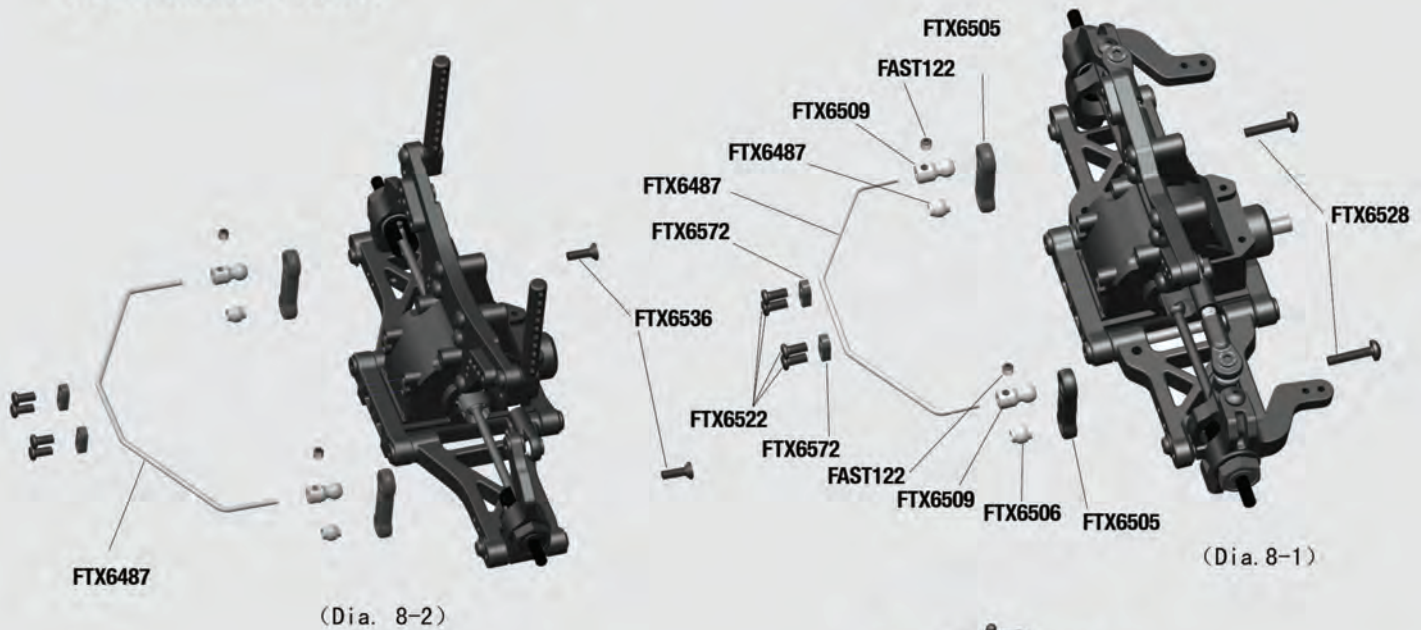

Front Bumper Assemblies.

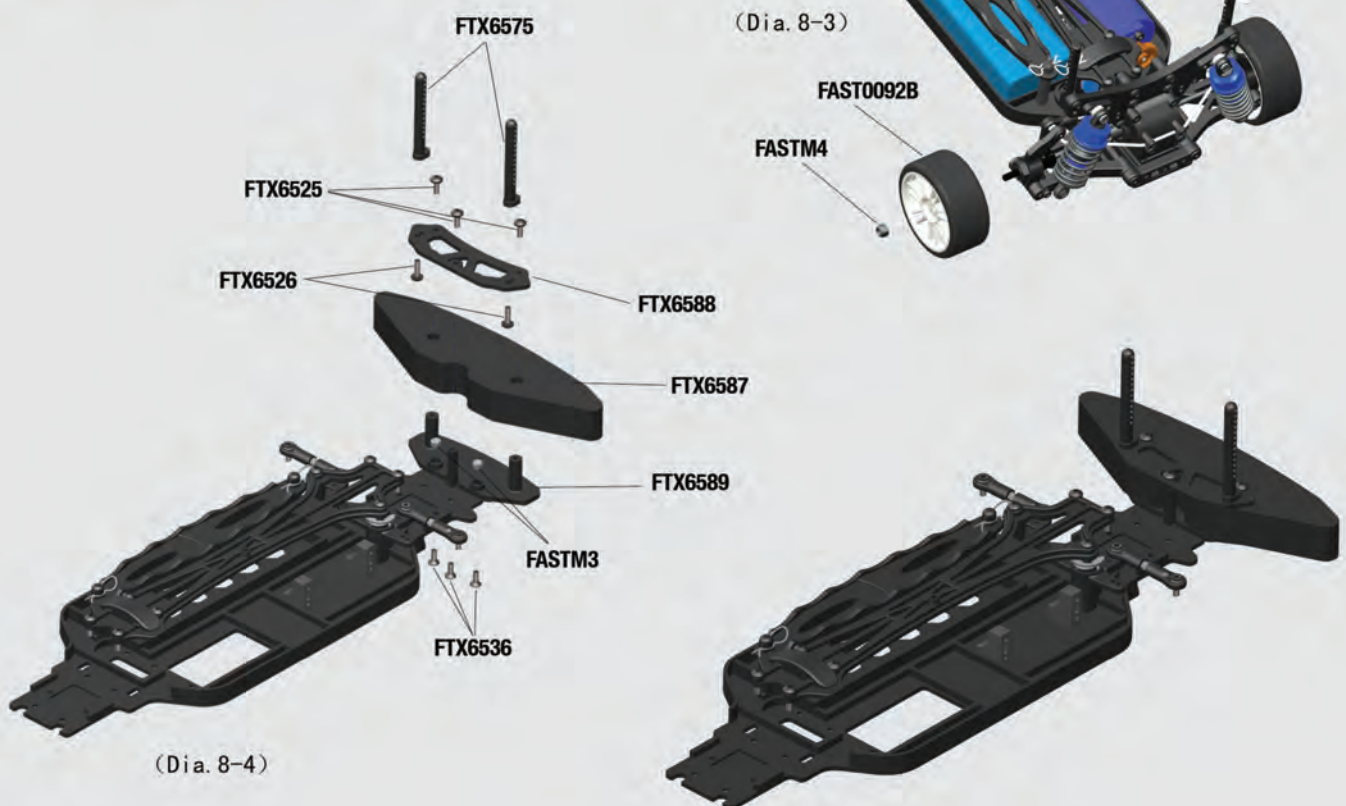

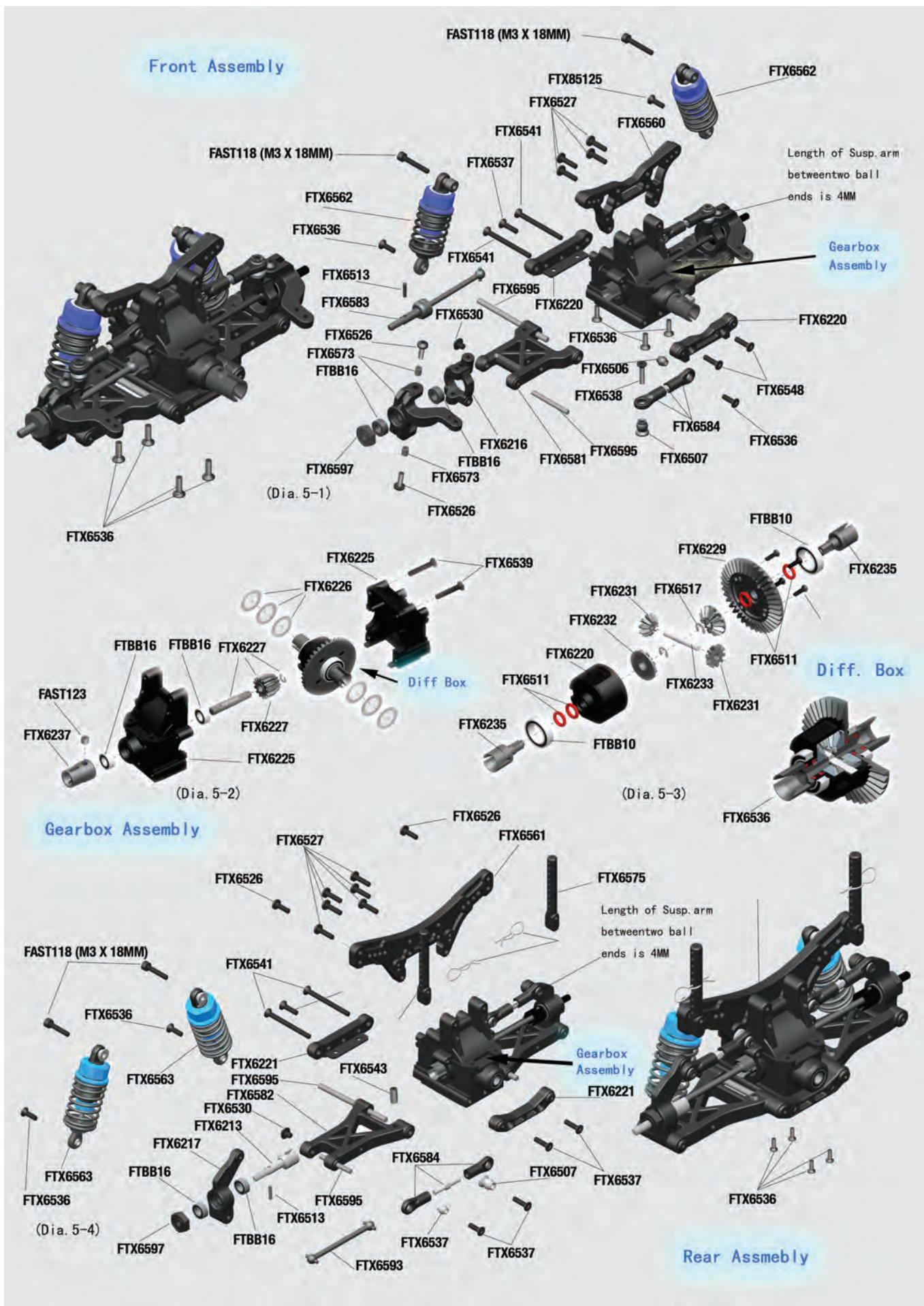



Central Assembly

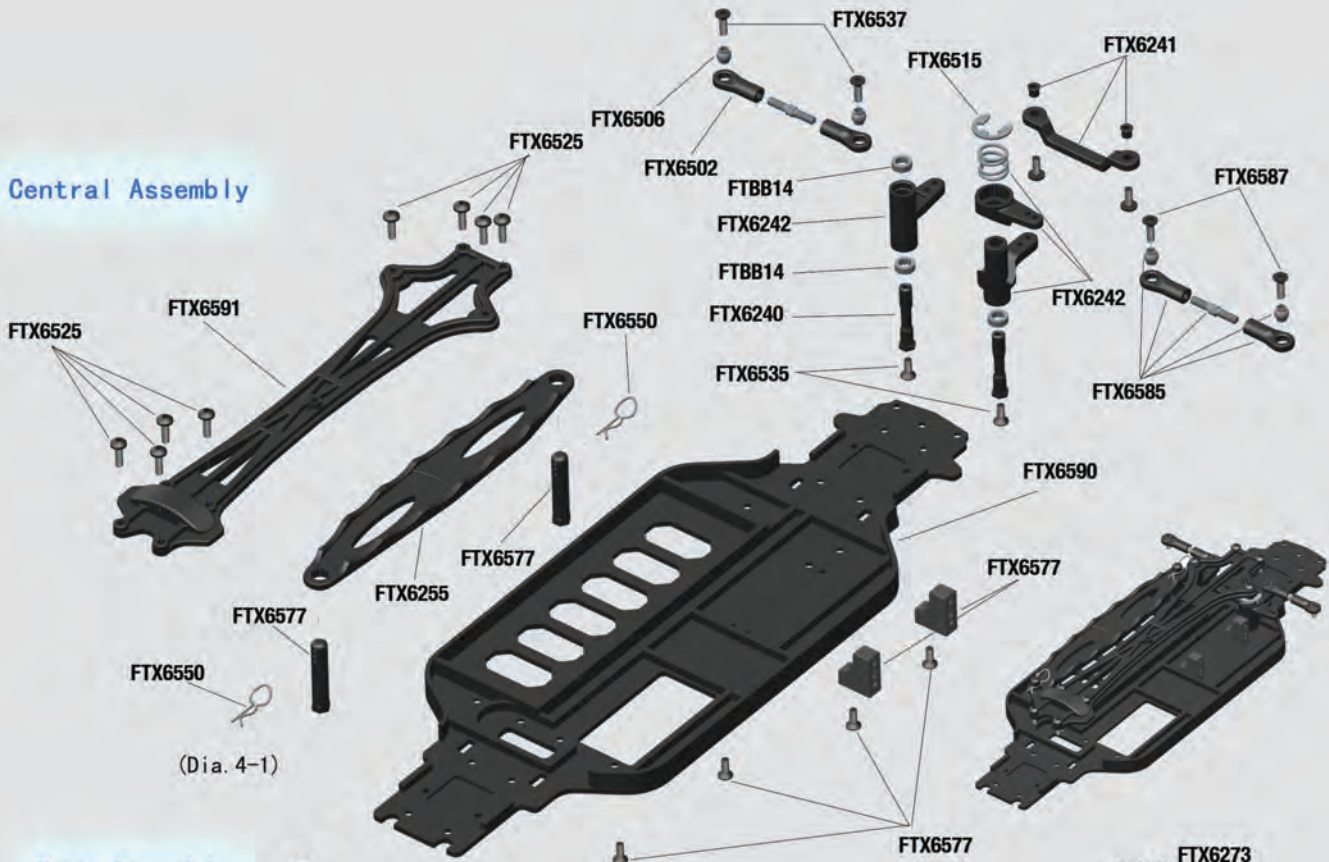

Rear Assembly



(Dia. 4-2)

Motor Assembly



(Dia. 4-6)

ESC



(Dia. 4-3)

Steering Assembly



(Dia. 4-4)

Receiver















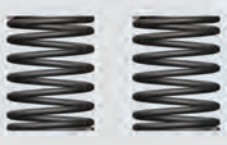











(Dia. 4-5)



























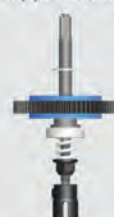

Common Part List

<p>FTX6560- Front Shock Tower 1pc</p> 	<p>FTX6561-Rear Shock Tower 1pc</p> 	<p>FTX6562-Front Shocks 2pc</p> 	<p>FTX6563- Rear Shock Tower 2pc</p> 
<p>FTX6564-Front Shock Spring 2pc</p> 	<p>FTX6565-Rear Shock Spring 2pc</p> 	<p>FTX6566-Front Shock Shaft & Piston Set 2sets</p> 	<p>FTX6567-Rear Shock Shaft & Piston Set 2sets</p> 
<p>FTX6568-Front Shock Body 2pc</p> 	<p>FTX6569-Rear Shock body 2pc</p> 	<p>FTX6570 -Shock Cap&Adjust Ring 2sets</p> 	<p>FTX6571-Shock Lower holder 2sets</p> 
<p>FTX6572-Sway Bar Fix Plate 6pcs</p> 	<p>FTX6573-Steering Knuckle Arm 1set</p> 	<p>FTX6216 -Uprights 2pc</p> 	<p>FTX6217-Rear Hub Carrier 2pc</p> 
<p>FTX6213-Rear Drive Shaft 2pc</p> 	<p>FTX6220-Front Susp. Holders 2pc</p> 	<p>FTX6221-Rear Susp. Holders 2pc</p> 	<p>FTX6225-Gearbox Housing Set 2pcs</p> 
<p>FTX6226-Diff 16T Gear Washer 6pcs</p> 	<p>FTX6227 -Diff. Drive Gear w/pin 2sets</p> 	<p>FTX6236-Diff Gearbox Set 1set</p> 	<p>FTX6228-Diff Case 2pcs</p> 























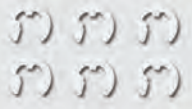
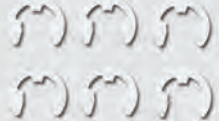

Part List

<p>FTX6230-Diff Drive Gear 2pcs</p> <p>13T</p> 	<p>FTX6235-Diff Bevel Gear S. 4pcs</p> <p>10T</p> 	<p>FTX6232 -Diff Bevel Gear B. 4pcs</p> <p>13T</p> 	<p>FTX6233-Diff pin 2pcs</p> 
<p>FTX6574-Pinion Gear 30T 1pcs</p> 	<p>FTX6235 -Diff Drive Cup 4pcs</p> 	<p>FTX6237 -Center Coupler 3pcs</p> 	<p>FTX6575 -Body Post 1set</p> 
<p>FTX6240-Servo Saver Post 2pcs</p> 	<p>FTX6241-Steering Ackerman 1set</p> 	<p>FTX6597-Wheel Hub 4pcs</p> 	<p>FTX6242 -Servo Saver 1set</p> 
<p>FTBB14 Bearing 8x5x2.5mm 6pcs</p> 	<p>FTX6576 -Servo Horn 1pc</p> 	<p>FTX6255 -Battery Cover 1pc</p> 	<p>FTX6577 -Battery and servo Post 1set</p> 
<p>FTX6505 -Sway Bar Holders 6pcs</p> 	<p>FTX6258 -Motor Mount 1pc</p> 	<p>FTX6578 -Slipper Complete 1set</p> 	<p>FTX6267 -Slipper Pad 2pcs</p> 
<p>FTX6268-Slipper Gasket 2pcs</p> 	<p>FTX6275 -65T Spur Gear 1pc</p> 	<p>FTX6579 -Slipper Shaft 1pc</p> 	<p>FTX6270 -Slipper Spring Bracket 1pc</p> 



Part List

<p>FTX6271-Slipper Spring 1pc</p> 	<p>FTX6273 -Slipper Drive Cup 1pc</p> 	<p>FTX6262 -Bearing Bracket 1pc</p> 	<p>FTX6500 -Shock Ball End 6pcs</p> 
<p>FTX6501 -Servo Link Ball End 6pcs</p> 	<p>FTX6502-Steering Linkage Ball End 6pcs</p> 	<p>FTX6507 -Ball B 6pcs</p> 	<p>FTX6506 -Ball A 6pcs</p> 
<p>FTX6508 -Ball C 6pcs</p> 	<p>FTX6510 -Shock 0-ring(Lower) 6pcs</p> 	<p>FTX6511 -Diff 0-ring Seal 6pcs</p> 	<p>FTX6580-Shock Seal Cover 4pcs</p> 
<p>FTX6513-Pin ϕ2*10 6pcs</p> 	<p>FTBB10 -Ball Bearing 15*10*4 6pcs</p> 	<p>FTX6515 -Ball Bearing 10*5*4 6pcs</p> 	<p>FTX6515 -E clip ϕ8mm 6pcs</p> 
<p>FTX6517-E clip ϕ2.5mm 6pcs</p> 	<p>FTX6516 -E clip ϕ4mm 6pcs</p> 	<p>FTX6581 -Front Lower Susp.Arm 2pcs</p> 	<p>FTX6582 -Rear Lower Susp.Arm 2pcs</p> 
<p>FTX6583 -Front CVD 2sets</p> 	<p>FTX6584-Upper Susp.Arm 4pcs</p> 	<p>FTX6585-Steering Arm 2pcs</p> 	<p>FTX6586 -Servo Linkage 1pc</p> 





Part List

<p>FTX6523 -Round Head Self Tapping Hex Screw 3*10 8pcs</p>	<p>FTX6522 -Round Head Self Tapping Hex Screw M3*6 6pcs</p>	<p>FTX6525 -Button Head Hex Screw M3*8 6pcs</p>	<p>FTX6526 -Button Head Hex Screw M3*10 6pcs</p>
<p>FTX6527 -Button Head Hex Screw M3*12 6pcs</p>	<p>FTX6528 -Button Head Hex Screw M3*14 6pcs</p>	<p>FTX6535 -Flat Head Hex M3*8 6pcs</p>	<p>FTX6536 -Flat Head Hex Screw M3*10 8pcs</p>
<p>FTX6537 -Flat Head Hex Screw M3*12 6pcs</p>	<p>FTX6538 -Flat Head Hex Screw M3*14 6pcs</p>	<p>FTX6539 -Flat Head Hex Screw M3*18 3pcs</p>	<p>FTX6540 -Flat Head Hex Screw M3*20 6pcs</p>
<p>FTX6541 -Flat Head Hex Screw M3*36 6pcs</p>	<p>FAST118 -Cap Head Hex Screw M3 X 18 6PCS</p>	<p>FAST115 -Cap Head Hex Screw M3*10 6pcs</p>	<p>FTX6530 -Ring Self Tapping Screw 3*4 4pcs</p>
<p>FTX6543 -Set Screw M4*10 6pcs</p>	<p>FAST123 -Set Screw M4*4 6pcs</p>	<p>FAST122 -Set Screw M3*3 6pcs</p>	<p>FASTM3 -Nylon Lock Nut M3 6pcs</p>
<p>FTX6543 -Nylon Lock Nut M4 6pcs</p>	<p>FTX6587 -Bumper sponge 1pcs</p>	<p>FTX6588 -Sponge cover 1pcs</p>	<p>FTX6589 -Bumper Rail 1pcs</p>















Part List

<p>FTX6590-Chassiss plate 1pcs</p> 	<p>FTX6591-Upper plate 1pcs</p> 	<p>FTX6592 -Bull board strengthen column 1pcs</p> 	<p>FTX6593 -Rear Dogbone 2pcs</p> 
<p>FTX6594 -Center Drive Shaft 1pcs</p> 	<p>FTX6595 -Hinge Pins(long & short) 1set</p> 	<p>FTX6559W-3kg/cm Servo 1pcs</p> 	<p>FAST0092B – Street/Drift Wheel & Tyre Set (4)</p> 
<p>ET1065 – Etronix 2.4ghz Sport ESR-1 Transmitter ET1090 – Etronix 2.4ghz Sport ESR-1 Receiver</p> 	<p>ET0411 Etronix 2.1W Brushless ESC</p> 	<p>FTX6551 -Body Clip(Small Size) 6pcs</p> 	<p>FTX6550 -Body Clip(Medium Size) 6pcs</p> 
<p>FTX6554 - 540 Brushed Motor 1pcs</p> 	<p>FTX6557W – 20A Waterproof Brushed ESC</p> 	<p>FTX6596 – Banzai Pre-printed body, decal & wing (un-cut)</p> 	<p>ET0330-335-3650(2950kv) Brushless Motor 1pcs</p> 
<p>VZ0010 – Voltz 1800mah NiMH Battery</p> 	<p>VZ0304 – Voltz 2500mah 7.4v 30C LiPo Battery (brushless esc only)</p> 		



Upgrade Parts List

<p>FTX6487 -Sway Bar 1set</p> 	<p>FTX6488 -Chassis (Carbon) 1pc</p> 	<p>FTX6489 -Front Shock Tower (Carbon) 1pc</p> 	<p>FTX6490 -Rear Shock Tower (Carbon) 1pc</p> 
<p>FTX6491 -Upper plate (Carbon) 1pc</p> 	<p>FTX6492 -Front Lower Susp. Arm (AL) 2pcs</p> 	<p>FTX6493 -Rear Lower Susp. Arm (AL) 2pcs</p> 	<p>FTX6494 -Steering Knuckle Arm (AL) 1set</p> 
<p>FTX6495 -Rear Hub Carrier (AL) 2pcs</p> 	<p>FTX6496 -Battery cover (AL) 3pcs</p> 	<p>FTX6497 -Front bumper cover (Carbon) 1pc</p> 	<p>FTX6498 -Front Shocks (AL) 2pcs</p> 
<p>FTX6499 -Rear Shocks (AL) 2pcs</p> 			



Notes:

Notes section with horizontal dotted lines for writing.



BANZAI



www.ftx-rc.com



FTX is an exclusive brand of CML Distribution, Saxon House, Saxon Business Park,
Hanbury Road, Bromsgrove, Worcestershire, B60 4AD England.
E-mail: info@ftx-rc.com