



OUTBACK FURY 2.0



ENGLISH INSTRUCTIONS – PAGE 2
FRANÇAIS INSTRUCTIONS – PAGE 9

INSTRUCTION BOOK AND COMPONENT LISTING



HOBBYWING®
ESC INCLUDED

www.ftx-rc.com





FTX Outback Fury 2.0 1/10th Scale 4WD Ready-To-Run Rock Crawler

Congratulations on your purchase of the FTX 'Outback Fury 2.0' electric off road car.

This 1/10th scale model has been factory assembled and all electrics installed and set up to make it the easiest possible introduction to the sport of driving RC cars.

WARNING: Read the ENTIRE instruction manual to become familiar with the features of the product before operating.

Failure to operate the product correctly can result in damage to the product, personal property and cause serious injury.

This is NOT a toy and must be operated with caution and common sense.

Failure to operate this product in a safe and responsible manner could result in damage, injury or damage to other property.

This product is not intended for use by children without direct adult supervision.

It is essential to read and follow all the instructions and warnings in the manual, prior to assembly, set-up or use, in order to operate correctly and avoid damage or serious injury.



Safety Precautions and Warnings

- You are responsible for operating this model such that it does not endanger yourself and others, or result in damage to the product or the property of others.
- This model is controlled by a radio which is possibly subject to interference which can cause momentary loss of control so it is advisable to always keep a safe distance to avoid collisions or injury.
- Age Recommendation: 14 years or over. This is not a toy. This product is not intended for use by children without direct adult supervision.

Carefully follow these directions and warnings, plus those of any additional equipment associated with the use of this model, chargers, ESC and motors, radio etc.

- Never operate your model with low transmitter batteries.
- Always operate your model in an open area away from cars, traffic or people.
- Never operate the model in the street or in populated areas.
- Always keep the vehicle in direct line of sight, you cannot control what you cannot see!
- Keep all chemicals, small parts and anything electrical out of the reach of children.
- Although splash-proof the car and electronics are not designed to be subjected to extended moisture exposure or submersion. To do so will result in permanent damage.
- Avoid injury from high speed rotating parts, gears and axles etc.
- Novices should seek advice from more experienced people to operate the model correctly and meet its performance potential.
- Exercise caution when using tools and sharp instruments.
- Do not put fingers or any objects inside rotating and moving parts.
- Take care when carrying out repairs or maintenance as some parts may be sharp.
- Do NOT touch equipment such as the motor, electronic speed control and battery, immediately after using your model because they can generate high temperatures.
- Always turn on your transmitter before you turn on the receiver in the car. Always turn off the receiver before turning your transmitter off.
- Keep the wheels of the model off the ground, and keep your hands away from the wheels when checking the operation of the radio equipment.
- Prolong motor life by preventing overheat conditions. Undue motor wear can result from frequent turns, rapid change of direction forwards/backwards, continuous stop/starts, pushing/pulling objects, driving in deep sand and tall grass, or driving continuously up hill.

Contents:

FTX Outback Fury 2.0 Rock Crawler RTR Vehicle
Transmitter: 2.4ghz Steerwheel
Charger: 500mA USB Charger
Battery: 2000mAH 7.2v



REQUIRED EQUIPMENT FOR OPERATION

1. Tools required for building and maintenance:

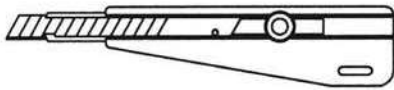

● Hobby knife

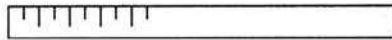

● Precision ruler

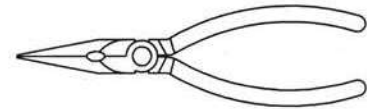

● Needle nose pliers

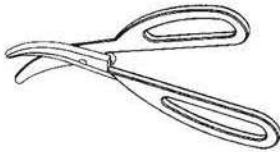

● Lexan scissors

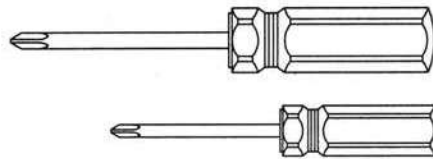

● Flat and Philips screwdriver

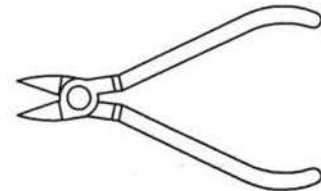

● Wire cutters

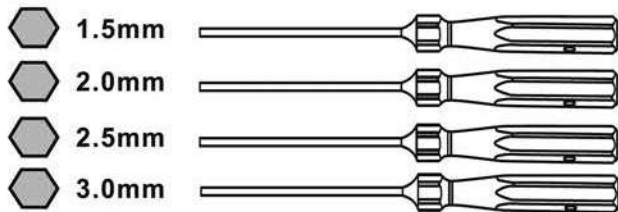

Hex. Screwdrivers

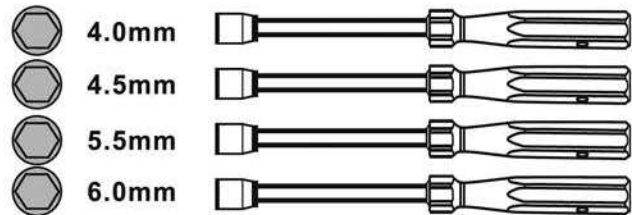

Socket Head Drivers

WARNING!

Do not use a power screw driver to install screws into nylon or plastic materials. The fast locking may heat up the screws being installed that may break the molded parts or strip the threads during installation.

2. Additional items needed for operation:



4 pcs AA Alkaline batteries for transmitter

IMPORTANT!

Check that all screws and nuts are tight before each use.



FAMILIARIZING YOURSELF WITH YOUR 2.4GHZ RADIO SYSTEM

Scheme Of Installation

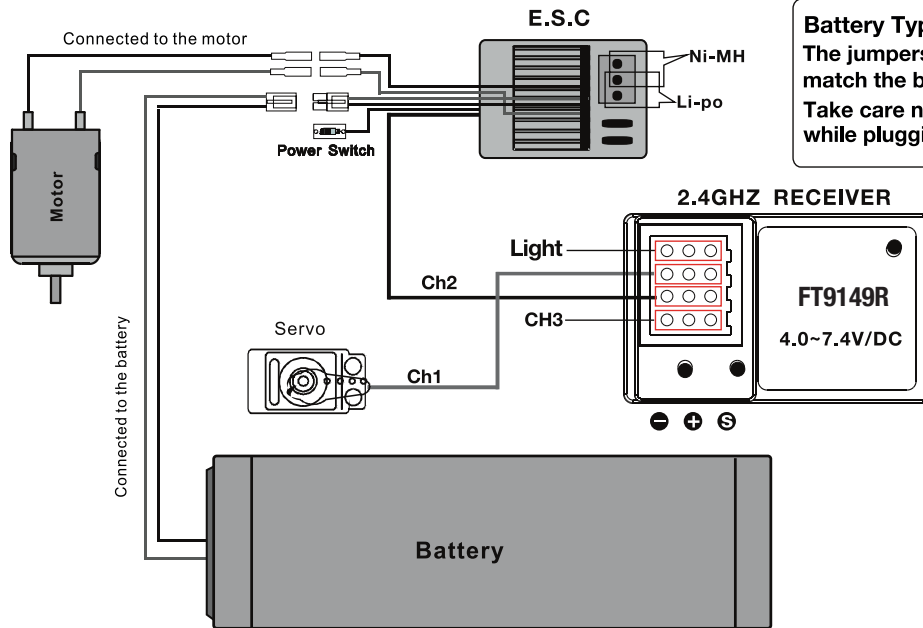

Battery Type Selection
The jumpers must be plugged to match the battery type used.
Take care not to damage the jumpers while plugging or unplugging them.

2.4GHZ Radio System

1. Transmitter overview:

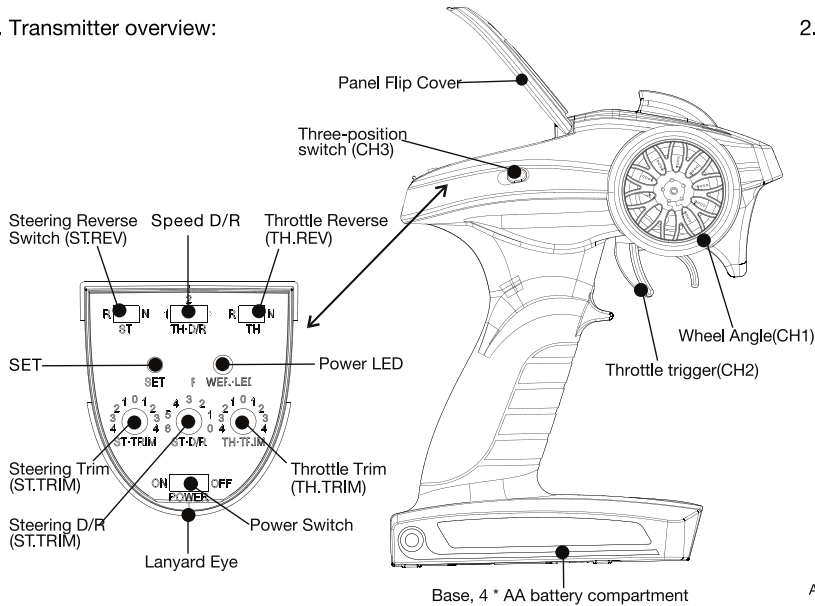

2. Receiver overview

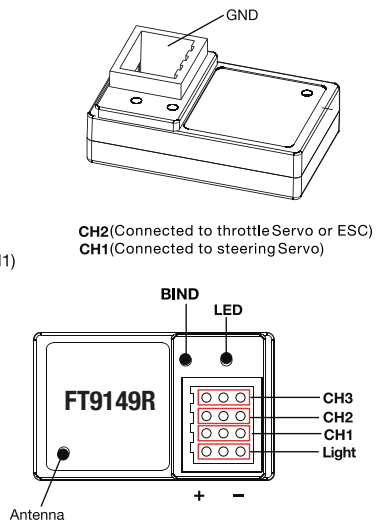

3. Transmitter Battery Installation

Battery Type: AA
Battery Installation:

1. Open the battery compartment cover.
2. Insert 4 fully-charged AA batteries into the compartment. Make sure that the battery makes good contact with the battery compartment's contacts.
3. Replace battery compartment cover.

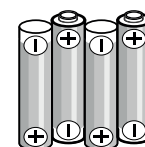
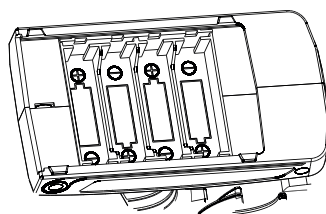

Batteries: 4 x 1.5 V "AA" (not included)

The battery socket is equipped with anti-reverse insertion function, wrong polarity connection will not burn the transmitter.



4. Power On

Follow the steps below to turn on the transmitter:

- 1). Check to make sure that that battery is fully charged and installed correctly.
- 2). Toggle the switch to the [ON] position. When active the R.LED will be lit.
- 3). Connect the receiver to power.

For safety always power on the transmitter before the receiver.

5. Binding

The transmitter and receiver have already been bound at the factory. However if the receiver needs to be replaced or additional receivers bound follow these steps:

- 1.) Turn off transmitter, power on the receiver and the receiver indicator will flash slowly;
- 2.) Press receiver Bind key for 2 seconds, then release the button, the indicator will flash fast;
- 3.) Power on transmitter, once the light flash, indicating entering the binding process
- 4.) Once binding is successful, the LED of receiver and transmitter will stop flashing.

applicable to the T-8196A transmitter and the RX-G3 receiver.

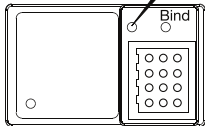

6. Beginner Mode

Beginner mode is designed for people new to the hobby.

Beginner mode Use the speed switch to control the forward speed.

- Gear 1: slow speed
- Gear 2: middle speed
- Gear 3: fast speed

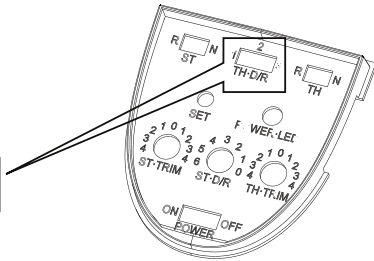
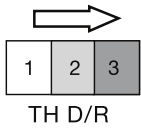

7. Fail-safe Setting

This transmitter has the fail-safe function.

The fail-safe setting as follow:

- 1). Ensure the transmitter and receiver successfully binding, and keep in working;
- 2). Control the throttle channel and make the servo or ESC enter braking state, then hold;
- 3). Press the transmitter set key twice, and the receiver and transmitter will flash three times and remain on, indicating the binding is successful;
- 4). To release the fail-safe, put all channel of the transmitter in neutral position and press twice.

8. Power OFF

Follow the steps below to turn off the system:

- 1). Disconnect the receiver power.
- 2). Toggle the transmitter's power switch to the off position.

Make sure to disconnect the receiver power before turning off the transmitter. Failure to do so may lead to damage or serious injury.

Warning
This product is only for 14 years old or above

Thank you for purchasing our product, an ideal radio system for beginners or experienced users. In order to ensure your safety, and the safety of others, read this manual carefully before using This product.

9. System Functions

1). Channel Description

The transmitter outputs a total of 3 channels, which are allocated as follows:

- CH1 Steering Wheel
- CH2 Throttle Trigger
- CH3 Three-position Switch

2). Channel Reverse

This function is used to adjust each channels direction of ment in relation to its input.

The ST.REV / TH.REV switches are the reverse buttons for CH1 and CH2. If the switch is right it indicates reverse, and the left indicates normal.

3). Trims

The ST.TRIM is the trims for CH1 (steering),

TH.TRIM is the trims for CH2(throttle).

Adjustment range: -120us- + 120us, each step is 4us;

ST.TRIM Clockwise / TH.TRIM Clockwise: increase adjustment step

ST.TRIM Anti Clockwise / TH.TRIM ANTI Anti Clockwise : Decrease adjustment step.

4). Steering D/R

ST.D / R is for servo travel adjustment

Adjustment range: 0-120%(the default is 100%), the step is 5%.

ST.D / R Clockwise: increase servo travel.

ST.D / R Anti Clockwise: decrease servo travel.

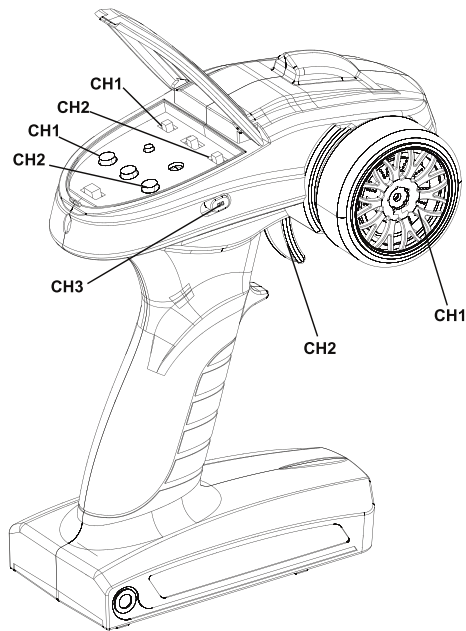

10. Precautions:

Never operate in bad weather, the radio will interfere and out of control;

Before running, keep the car or boat in static state for easy operation

Always turn off the receiver before turning the transmitter off. Once wrong, the car will out of control and make accidents.

When power on the transmitter, should not do any action on the transmitter, otherwise it will get out of control.



RUNNING YOUR CAR

1. TURN ON THE RADIO CONTROLLER

Switch on the power switch on the radio controller. Your radio is bound with your car automatically.



2. TURNING ON THE RECEIVER OF YOUR CAR

The ESC Receiver switch is located under the bodyshell of the model. Switch on the ESC/Receiver Switch as shown in the picture.

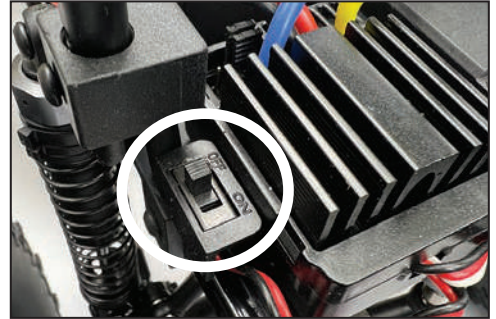

3. CHECK STEERING PERFORMANCE

CENTRE

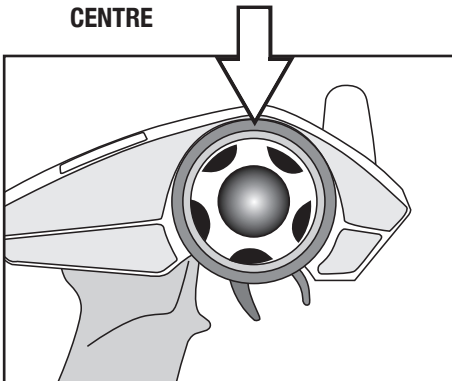

1. To keep the car running straight, keep the steering wheel centered.

TURN RIGHT

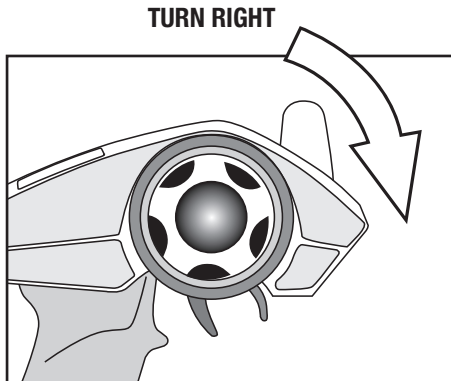

2. Turn the steering wheel to the right to allow the car to right.

TURN LEFT

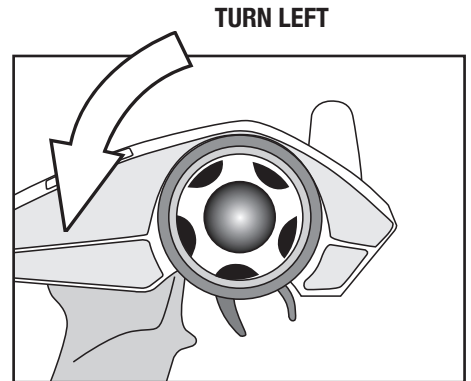

3. Turn the steering wheel to the left to allow the car to turn to the left.

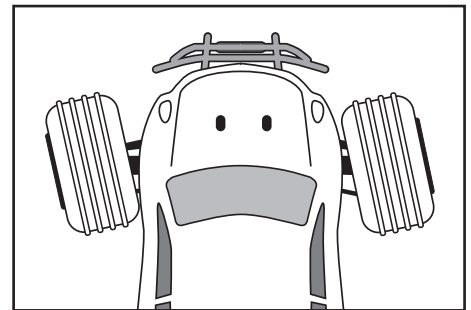
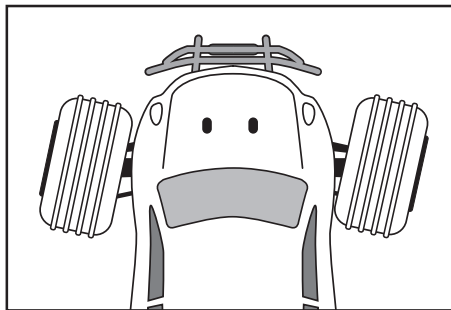
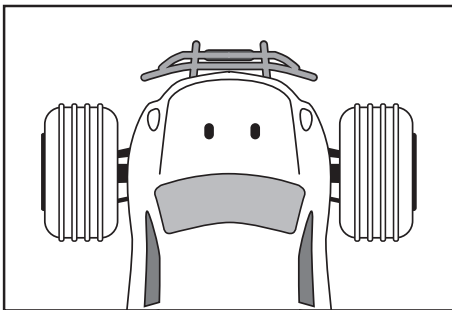

4. CHECK TRIGGER RESPONSE

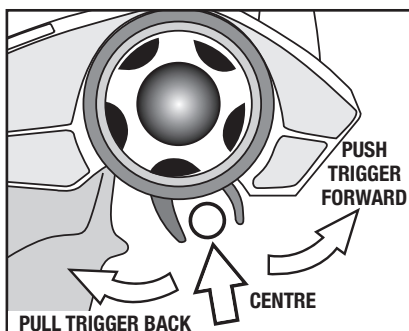

PLEASE NOTE: THE MODEL SWITCHES BETWEEN FORWARD AND REVERSE INSTANTLY FOR SLOW SPEED MANEUVRABILITY. EXCESSIVE USE OF THIS FEATURE CAN CAUSE TRANSMISSION AND ESC DAMAGE.

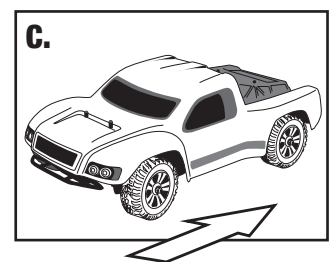
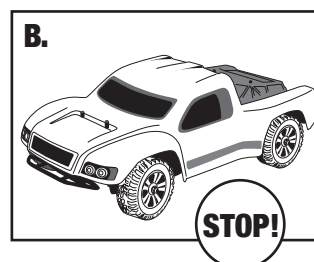
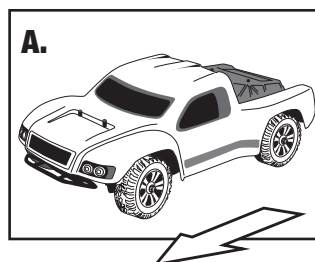

A. Pull the trigger back to accelerate, release it to decelerate.
B. To stop running your car, release the trigger to neutral.
C. Pushing the trigger forward activates reverse.



RUNNING YOUR CAR

5. TUNING THE STEERING TRIM

STEERING TRIM KNOB

Gently pull the trigger to allow your car to run slowly. Meantime, tune the steering trim to allow the front wheels to be aligned.

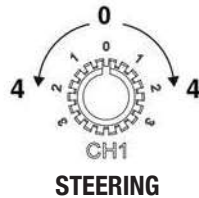

6. TUNING THE THROTTLE TRIM

THROTTLE TRIM KNOB

Throttle Trim is used to set the idle speed of the car.



7. TO TUNE THE STEERING DUAL RATE CONTROL DIAL

STEERING D/R KNOB

This dial adjusts the overall travel of the steering servo. Push the dial forward for maximum steering. Pull the dial back to reduce the steering level.

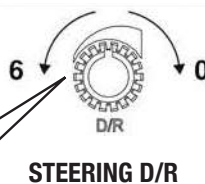
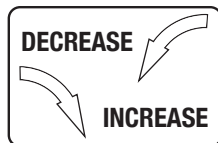

Set the Steering Dual Rate Control Dial to minimum first. To set the desired steering wheel level increase it again whilst decelerating your vehicle.

8. STEERING/THROTTLE REVERSE

STEERING REVERSE: Allows you to electronically switch the direction of steering servo travel. For example, if you move the steering wheel to the right and the steering servo moves to the left, flip the the Steering Reverse switch to make the steering servo to the left.

THROTTLE REVERSE: Allows you to electronically switch the direction that the motor operates in relation to the throttle trigger. For example, if you pull the throttle trigger to accelerate forward but the model goes in reverse, flip the Throttle Reverse switch to make the model accelerate forward.

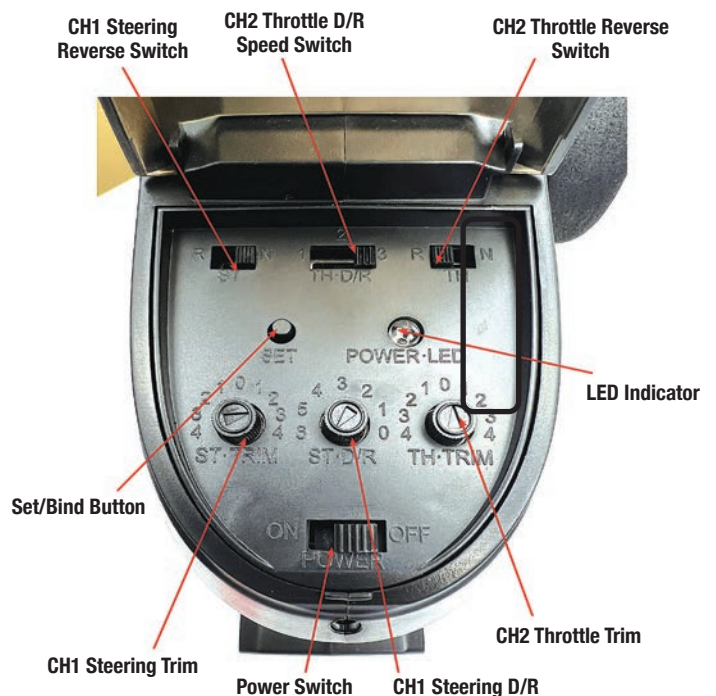



CHARGING

8 CHARGING/INSTALLING THE BATTERY

- Always store your model with the battery pack unplugged and removed.
- Always charge your battery away from the vehicle.
- The included USB charger will take approximately 4 hours to charge a discharged 2000mAh battery.
- When charging the Red LED will be solid.
- When the battery is fully charged the Green LED will be solid.

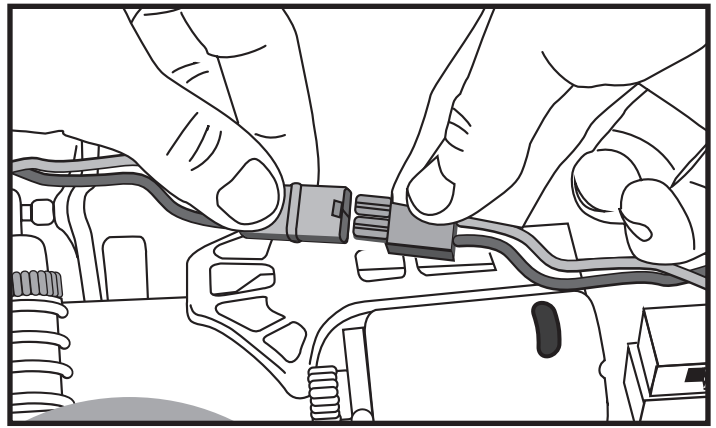
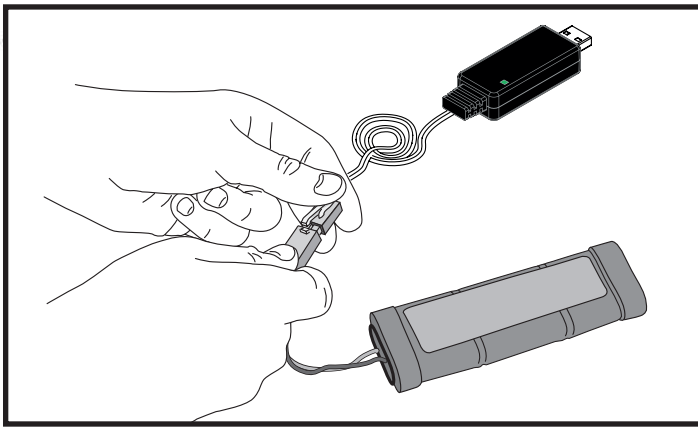

- The battery will become warm to touch when charged, but not hot.
- If the battery is hot, stop charging immediately. Disconnect the battery from the charger as soon as the charger LED turns green.

9 NOTES ON BATTERY USE

- Always allow the battery cool after use, before recharging.
- Always inspect the battery before charging.
- Any bare wires, split heat shrink or leakage is a sure sign of abuse.
- Never attempt to charge dead or damaged batteries.
- Do not disassemble the battery or cut the connector wires.
- If the battery connector gets hot enough to melt there is most likely a serious problem with your model, driveline, battery wires or speed controller. Find and correct the problem before installing another charged battery pack.
- NEVER charge the battery unattended incase of overcharging, you need to be able to monitor the battery during charging.
- Charge away from flammable objects and on a non-flammable surface incase the battery becomes too hot.

(Note: Your model is already bound from the factory)



Getting Started

Switch on transmitter. Hold vehicle clear of the ground, connect battery pack and switch on receiver. Bind the Transmitter and receiver if required.

Test the transmitter to check control of the vehicle with wheels off the ground. Start driving slowly and if the vehicle does not go straight, adjust steering trim dial on Transmitter. For the very first run use the throttle gently, to gradually bed in the motor brushes and help the driver become accustomed to the vehicles behaviour and controls.

PLEASE NOTE:

Although the electronics are waterproof the rest of car can be subjected to damage if running in excessively wet or submerged conditions.

After Run.

Switch off the receiver power, switch off the transmitter and lower the aerial. Disconnect the battery and remove it from the vehicle, allow it to cool before recharging. If you have a second charged battery all ready to use, still allow the vehicle to cool slightly before continuing.

Regular maintenance.

Frequently check the whole vehicle for loose or missing fixings. Use thread lock on any replacement screws into metal threads.

Frequently check rotating parts are free from grass, string etc. that might bind their motion and over stress the motor or speed controller. Remove the wheels occasionally and check behind the mounting hex for obstructions or anything that might have been wrapped around the axle and caused extra drag.

Shock absorbers will wear prematurely if used in dirty dusty conditions. Replace oil and seals as required to keep a smooth dampening action.

Warranty

Due to the nature of this product and potential use FTX warrants it to be free of material and workmanship defects when new. FTX will at its sole discretion repair or replace defective components free of charge within 30 days from date of purchase. This warranty does not cover wear and tear, crash or impact damage, modifications, component water damage failure to perform maintenance or damage from improper use. Proof of purchase date will be required to action any warranty claims. In no case shall FTX's liability exceed the original cost of the purchased kit.

Trouble shooting guide.

SHORT RUNTIME:	SLUGGISH ACTION:	MOTOR/ESC OVERHEAT:	MOTOR SPINS BUT VEHICLE REFUSES TO MOVE:	POOR RANGE OR FAILS TO OPERATE:
Battery damaged/not charged Motor dirty or brushes worn Drivetrain binding	Motor dirty or brushes worn Bind in drive train Battery running low on power	Over-gearred Binding transmission. Seized axle bearing. Motor binding	Gears damaged. Gears loose on shaft. Drive shaft broken or missing.	Transmitter batteries low Vehicle Battery Low. Transmitter switched off Transmitter/receiver aerial not extended. ESC switched off or battery not connected. Loose connectors/wires.

Instructions for disposal.

Environmental Protection Notes & WEEE

The crossed-out wheeled bin symbol shown here, which may be found on the product itself, in the operating instructions or on the packaging, is in accordance with the Waste Electrical and Electronic Equipment (WEEE) Directive. Individual markings indicate which materials can be recycled and re-used. You can make an important contribution to the protection of our common environment by re-using the product, recycling the basic materials or recycling redundant equipment in other ways.

When this product comes to the end of its useful life, you must not dispose of it in the ordinary domestic waste. Many electrical items that we throw away can be repaired or recycled. Recycling items helps to save natural resources and also reduces the environmental and health impacts that are linked with sending electrical goods to landfill. The correct method of disposal is to take it to your local collection point for recycling electrical and electronic equipment. You can go to recycle-more.co.uk for details of locations.

Alternatively FTX can offer our customers free take-back of their WEEE on a like-for-like basis when they buy a new Electrical or Electronic product from us. For example, if a customer bought a new radio system from us or a dealer, we would accept their old radio and prevent it going into a landfill site by disposing of it safely. Customers must return their old WEEE item to us within 28 days of purchasing their new item.

Remove batteries from your device and dispose of them at your local collection point for batteries. If you don't know the location of your nearest disposal centre, please enquire at your local council office.



CML Distribution, Saxon House, Saxon Business Park, Hanbury Road,
Bromsgrove, B60 4AD.





Le FTX Outback Fury 2.0 4x4, une voiture de trail à l'échelle 1/10 prête à rouler

Merci d'avoir choisi le FTX Outback Trail 4x4 électrique. Ce modèle est monté d'usine, l'électronique est pré installée et réglée pour permettre un démarrage et du plaisir le plus rapidement possible.

This 1/10th scale model has been factory assembled and all electrics installed and set up to make it the easiest possible introduction to the sport of driving RC cars.

Attention: lisez l'intégralité du manuel pour exploiter au mieux la voiture et éviter des dommages mécaniques ou corporels. Ce modèle n'est pas un jouet, il doit être manipulé avec précaution. Utilisé dans de mauvaises conditions, ce modèle peut causer des dommages.

Ce modèle n'est pas fait pour être utilisé par un enfant sans la surveillance directe d'un adulte.

Il est essentiel de lire et de suivre les instructions et les recommandations de ce manuel pour entretenir et faire évoluer votre modèle dans de bonnes conditions.

Mesures de sécurité:

- Vous êtes responsable lors de l'évolution de ce modèle, veillez à ne pas vous mettre en danger, à mettre en danger le modèle ou la propriété d'autrui.
- Ce modèle radiocommandé peut être perturbé par d'autres sources d'onde radio, ce qui peut entraîner la perte momentanée du contrôle de la voiture.
- Age recommandé : 14 ans, ceci n'est pas un jouet, ce produit n'est pas fait pour être utilisé par un enfant sans surveillance.

Suivez consciencieusement les instructions suivantes :

- Ne jamais évoluer avec des batteries d'émission faibles
- Toujours évoluer dans une zone dégagée, loin de la circulation et de la foule
- Ne jamais évoluer dans une rue ou un endroit fréquenté
- Toujours garder le modèle dans son champ de vision
- Gardez hors de portée des enfants tous les composants de petite taille, électriques ou chimiques
- Tenez le modèle hors de portée de l'eau (la rouille peut causer des dommages irréversibles au modèle)
- Faites attention aux pièces en rotations, axes, pignons etc.
- Les débutants doivent prendre conseil auprès de personnes plus expérimentées
- Faites attention lors de l'utilisation des outils
- Attention à ne pas mettre les doigts ou d'autres parties du corps en contact avec les pièces en rotation
- Faites attention lors du transport, de la maintenance ou de la réparation, certaines pièces peuvent être coupantes.
- NE JAMAIS toucher les composants tels que le moteur, le variateur ou les batteries après utilisation, ces pièces peuvent être chaudes
- Lorsque vous changez de fréquence d'émission assurez-vous que les quartz de fréquence sont bien positionnés (RX pour récepteur et TX pour l'émetteur)
- Toujours éteindre en premier la voiture avant l'émetteur
- Vérifiez le bon fonctionnement de la voiture les roues dans le vide (en prenant les précautions nécessaires)
- Prolongez la durée de vie du moteur en le préservant de la surchauffe (la durée de vie du moteur dépend aussi de la fréquence de roulage, des changements rapide de direction avant/arrière, des conditions de roulage difficiles poussière/boue des utilisations abusives tirer/pousser des objets)

Contents:

- 1 FTX Outback Fury 2.0 1/10ème prêt à rouler électrique
- 1 Emetteur à volant fréquence 2.4GHz
- 1 Chargeur: USB 500mA
- 1 Batterie: 7.2V 2000mAh NiMH

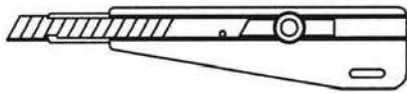

EQUIPMENTS REQUIS POUR LA MAINTENANCE:

● Cutter

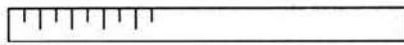

● Règle

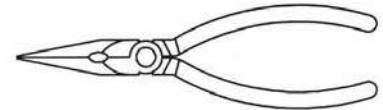

● Pince

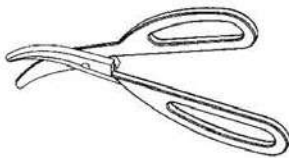

● Ciseaux à lexan

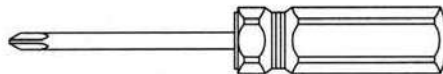

● Tournevis plats et cruciformes

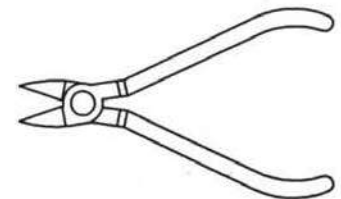
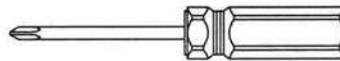

● Pince coupante

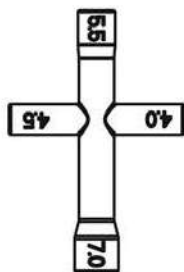

● Clé

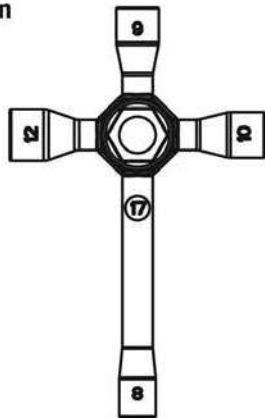

● Colle à pneu



● Frein filet

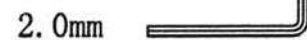
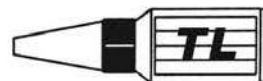

● Clé Allen

ATTENTION: L'utilisation d'une visseuse électrique pour la maintenance pourrait endommager l'emprunte des vis ou casser des pièces du modèle.

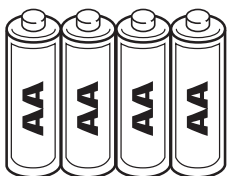

4 piles alcalines AA pour l'émetteur

IMPORTANT: Veuillez vérifier le serrage de chaque vis et écrous avant l'utilisation du modèle.



FAMILIARISEZ VOUS AVEC VOTRE SYSTÈME RADIO 2.4 GHZ

Scheme Of Installation

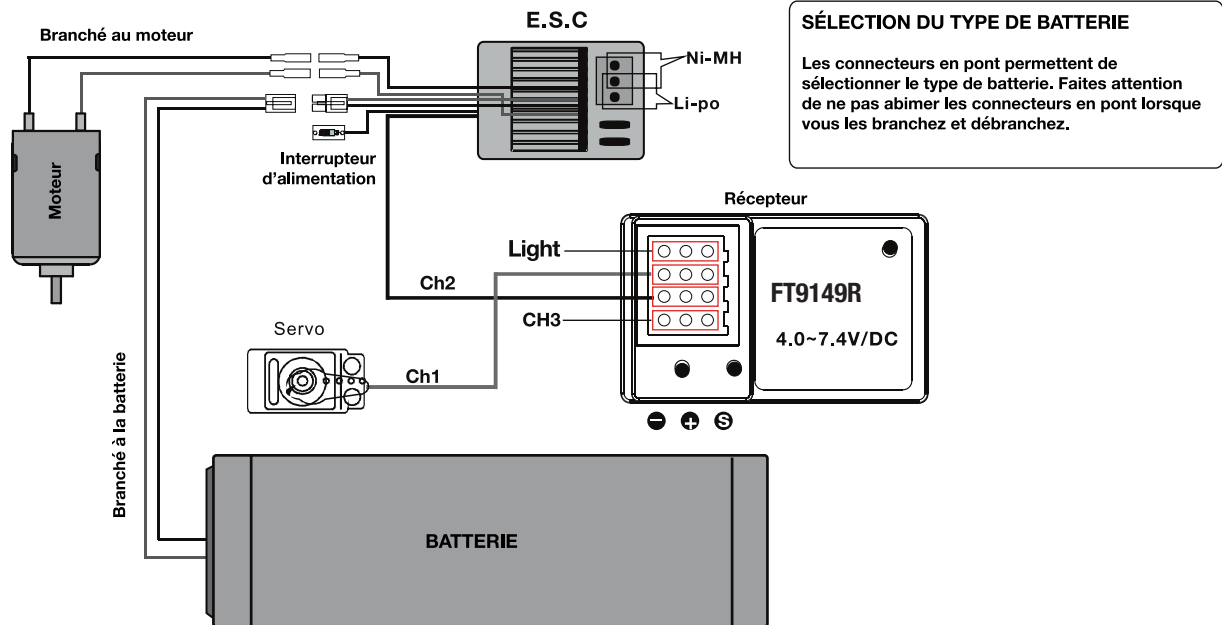

SÉLECTION DU TYPE DE BATTERIE
 Les connecteurs en pont permettent de sélectionner le type de batterie. Faites attention de ne pas abîmer les connecteurs en pont lorsque vous les branchez et débranchez.

SYSTÈME RADIO 2.4 GHZ

1. Présentation de la télécommande

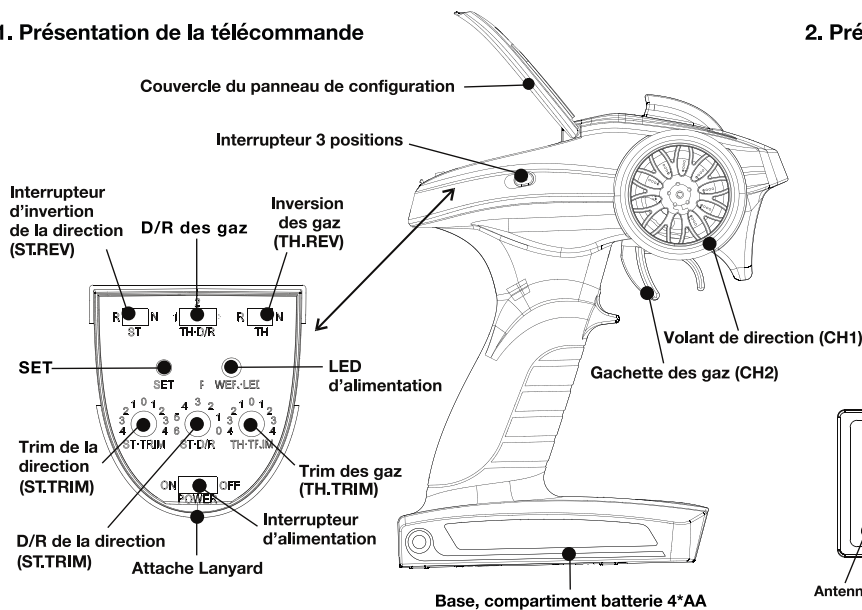

2. Présentation du récepteur

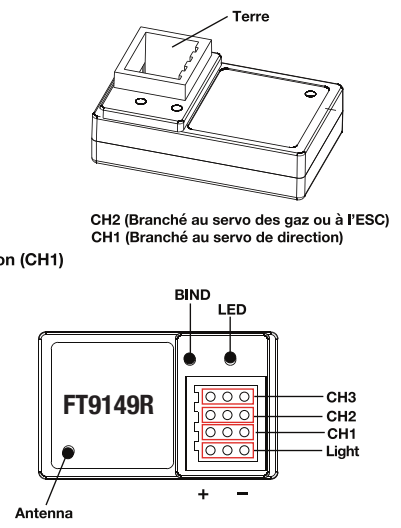

3. Montage des piles dans la télécommande

Type de pile : AA
 Montage des piles:

- 1). Ouvrir le compartiment batterie
- 2). Insérer les 4 piles AA dans le compartiment. Assurez-vous que le contact soit correct et que les polarités soient respectées
- 3). Remonter le compartiment batterie
 Alarme de batterie faible : Lorsque les piles descendent en dessous de 4.4V, la LED verte sur le panneau de la télécommande va clignoter doucement

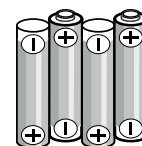
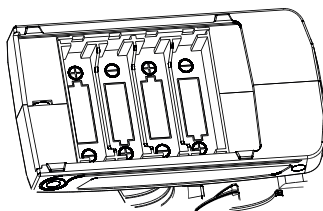

⚠ Le système d'alimentation de la télécommande est équipé d'un système contre les mauvaises polarités. Une erreur de polarité ne va donc pas cramer la télécommande.



4. Allumer la télécommande

Suivre les étapes suivantes pour allumer la télécommande :

- 1). Assurez-vous que les piles soient entièrement chargées et correctement montées
- 2). Faites glisser l'interrupteur sur la position ON. Lorsque la télécommande est allumée, la LED rouge s'allume.
- 3). Alimentez le récepteur

 Pour votre sécurité, allumer toujours la télécommande avant le récepteur

5. Appairage

La télécommande et le récepteur sont déjà appareillés en sortie d'usine. Cependant, si le récepteur doit être remplacé ou que vous souhaitez utiliser différents récepteurs, suivez les étapes ci-dessous !

- 1). Eteindre la télécommande, allumer le récepteur, la LED dessus va alors clignoter
- 2). Rester appuyer pendant 2 sec sur la touche Bind du récepteur, relâcher le bouton, la LED va alors clignoter rapidement
- 3). Allumer la télécommande, une fois que la LED clignote, cela indique qu'elle est rentrée en mode appairage
- 4). Lors que l'appareillage est terminé, la LED du récepteur s'arrête de clignoter

 Cela s'applique pour la télécommande T-8196A et le récepteur RX-G3

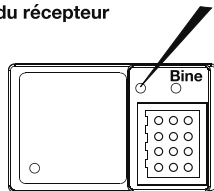

6. Mode débutant

Le mode débutant permet d'assister les personnes qui découvre la passion du modèle réduit. Ce mode utilise un interrupteur pour contrôler la vitesse

- Position 1 : Vitesse lente
- Position 2 : Vitesse moyenne
- Position 3 : Vitesse rapide

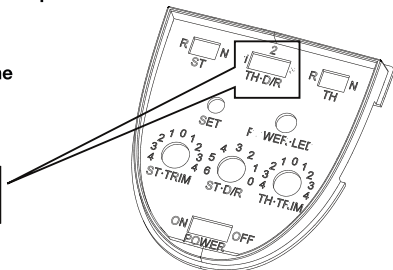
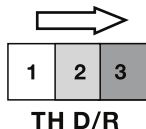

7. Réglage du Fail-Safe

Cette télécommande possède une fonction de fail-safe. Pour régler le fail-safe, suivez les étapes ci-dessous :

- 1). Assurez-vous que la télécommande et le récepteur soient correctement appareillés
- 2). Ajuster la commande des gaz pour faire freiner le servo ou l'ESC
- 3). Appuyer sur la touche SET de la télécommande 2 fois, la télécommande et le récepteur vont alors clignoter 3 fois, ce qui indique que la liaison a été effectuée
- 4). Pour annuler le fail safe, laisser les commandes au neutre, et appuyer 2 fois sur la touche SET

8. Eteindre

Pour éteindre le système, suivre les étapes ci-dessous :

- 1). Eteindre le récepteur
- 2). Eteindre la télécommande et faisant glisser l'interrupteur d'alimentation sur OFF

 Assurez-vous de débrancher le récepteur avant d'éteindre la télécommande. Un non-respect de cette règle peut entraîner des dommages ou des blessures

 **Warning**
This product is only for 14 years old or above

Merci d'avoir acheté notre produit, qui n'est autre qu'un système radio idéal aussi bien pour les débutants que les utilisateurs expérimentés. Afin d'assurer votre sécurité, et la sécurité des autres, lisez ce manuel attentivement avant d'utiliser ce produit.

9. Description des fonctionnalités du système

- 1). Description des voies
La télécommande possède un total de 3 voies qui sont réparties sur :
CH1 : Le volant de direction
CH2 : La gachette des gaz
CH3 : L'interrupteur 3 positions
- 2). Inversion des voies
Cette fonctionnalité permet d'inverser le sens de chaque voie. Les interrupteurs ST.REV et TH.REV permettent d'inverser les voies CH1 et CH2. Si l'interrupteur est sur la droite, la commande est inversée, la position à gauche représente donc le sens classique
- 3). Trims
Le ST.TRIM est le trim de la voie 1 (direction)
Le TH.TRIM est le trim de la voie 2 (gaz)
Plage de réglage : -120us à +120us, avec des incréments de 4us. Si vous tournez les ST.TRIM et TH.TRIM dans le sens des aiguilles d'une montre, vous augmentez la valeur du réglage. Si vous tournez les ST.TRIM et TH.TRIM dans le sens inverse des aiguilles d'une montre, vous diminuez la valeur du réglage
- 4). D/R de la direction
La molette ST.D/R permet de régler le débattement du servo. Le réglage va de 0 à 120% avec une valeur par défaut à 100%. Chaque cran augmente de 5% le réglage. Si vous tournez le ST.D/R dans le sens des aiguilles d'une montre, vous augmentez la valeur du réglage. Si vous tournez le ST.D/R dans le sens inverse des aiguilles d'une montre, vous diminuez la valeur du réglage

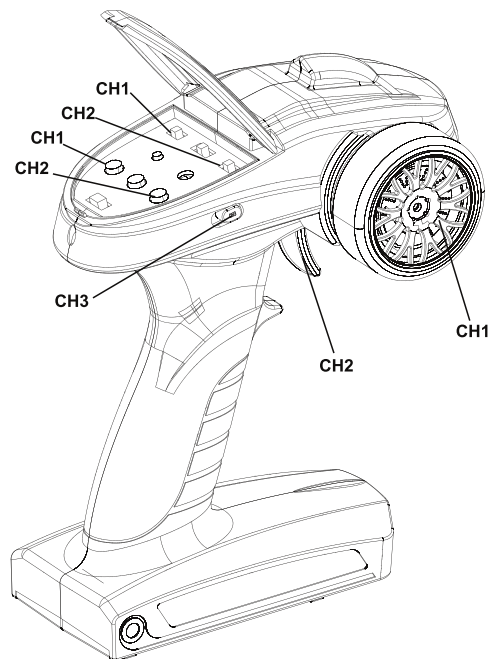

10. Précautions:

N'utilisez jamais la télécommande si les conditions météorologiques sont mauvaises, sinon ils pourraient y avoir des interférences qui vous ferez perdre le contrôle. Avant de rouler, garder la voiture ou le bateau en statique pour intervenir plus facilement dessus.

Eteignez toujours le récepteur avant la télécommande. Si vous faites l'inverse, la voiture pourrait faire n'importe quoi et créer des accidents. Lorsque vous allumez la télécommande, vous ne devriez pas toucher aux commandes afin d'éviter tout problème.



GESTION DE VOTRE VOITURE

1. METTRE LA RADIO SUR ON

Mettre le bouton d'allumage de la radio sur ON. Votre voiture est automatiquement appairer avec votre radio.



2. METTRE SUR ON INTERRUPTEUR

L'ensemble variateur/ récepteur se situe sur ON comme montré sur la photo.



3. ASSURE UNE BONNE PERFORMANCE DE PILOTAGE

CENTRE

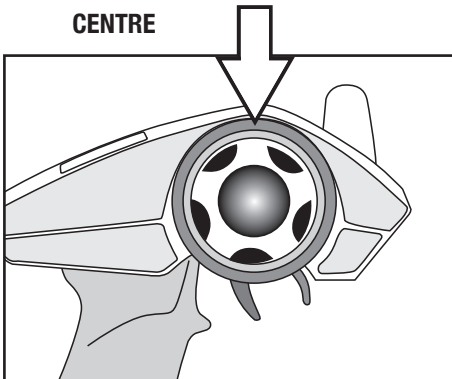

1. Pour que la voiture aille droite ne pas tourner le volant (le laisser au centre).

TOURNE À DROITE

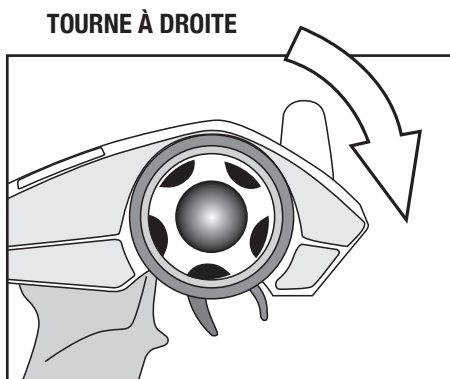

2. Tourner à droite pour permettre à votre d'aller à gauche.

TOURNE À GAUCHE

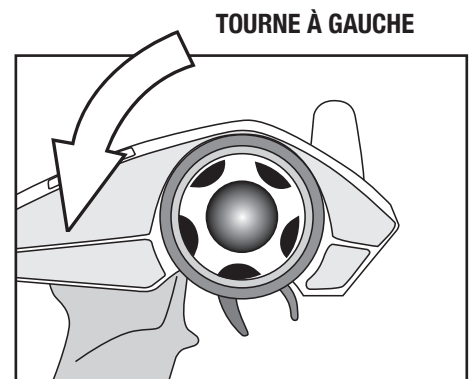

3. Tourner à gauche pour permettre à votre voiture d'aller à droite.

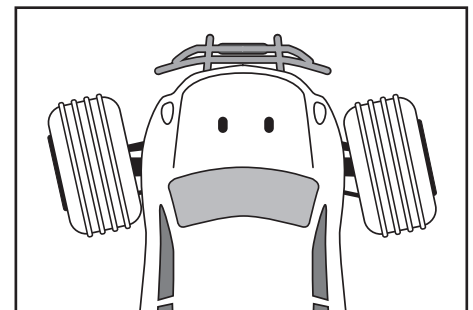
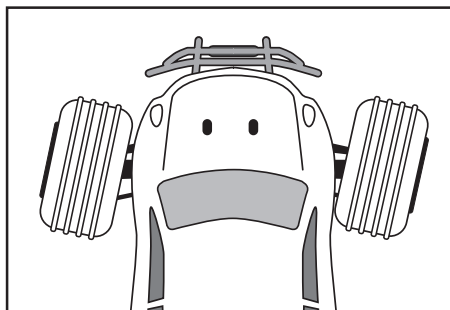
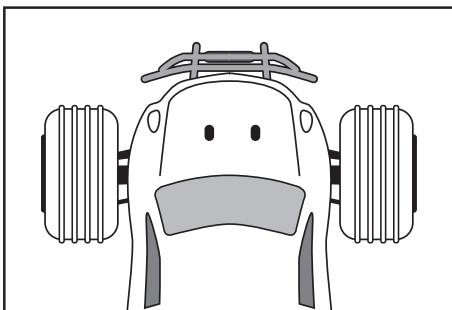

4. VÉRIFIER LA REEONSE DE LA GACHETTE

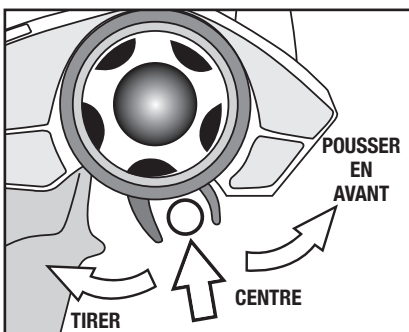

S'IL VOUS PLAÎT NOTEZ :

LE MODÈLE PASSE ENTRE LA MARCHÉ AVANT ET ARRIÈRE INSTANTANÉMENT POUR UNE MANŒVRABILITÉ À FAIBLE VITESSE. UNE UTILISATION EXCESSIVE DE CETTE FONCTIONNALITÉ PEUT ET VA ENDOMMAGER LA TRANSMISSION ET L'ESC.

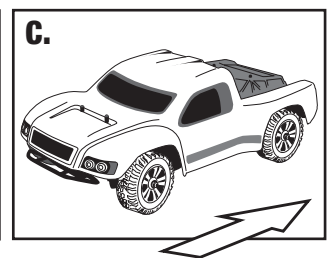
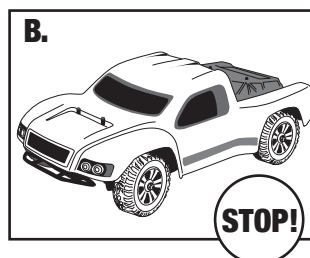
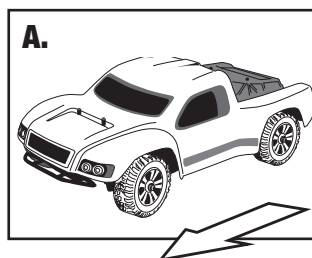

A. Tirer la gâchette en arrière pour accélérer? La lâcher pour décélérer et la pousser pour freiner.

B. Pour arrêter la voiture, lâchette jusqu'au neutre.

C. Pousser la gâchette vers l'avant active la marche arrière.

GESTION DE VOTRE VOITURE

5. POUR MODIFIER LE TRIM DE DIRECTION

Placer la voiture sur le stand avec les roues qui ne touchent pas le sol, puis régler le Trim de direction pour aligner les roues avant.

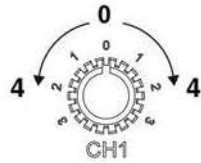

TRIM DE DIRECTION



6. POUR MODIFIER LE TRIM DE GAZ

Trim des gaz est utilisé pour régler la vitesse de ralenti

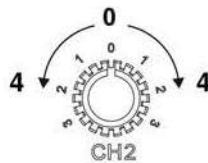

TRIM DE GAZ



7. POUR MODIFIER LA COURSE (DIR) DE LA DIRECTION

Ce réglage ajuste la course du servo de direction. Pousser le bouton en avant pour un maximum de directivité. Tirer en arrière pour réduire la course du servo.

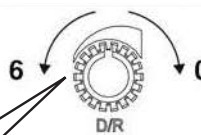

DIRECTION DIR

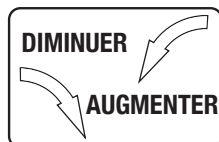

Note: Toujours minimiser et augmenter ensuite pendant que votre voiture.

CH1 Interrupteur d'inversion de la direction

CH2 D/R des gaz

CH2 Inversion des gaz

8. REG/AGE DES REVERSES DIRECTION/GAZ

DIRECTION REVERSE:

Cela permet électroniquement d'inverser le sens de rotation du servo. Par exemple si vous si vous tournez le volant à droite.

GAZ REVERSE:

Cela vous permet de changer électroniquement la direction dans laquelle le moteur opère en relation avec la gâchette des Gaz. Par exemple, si vous poussez la gâchette pour accélérer en avant, mais le model va en arrière, inverser le Gaz Reverse permettra au model d'accélérer en avant.

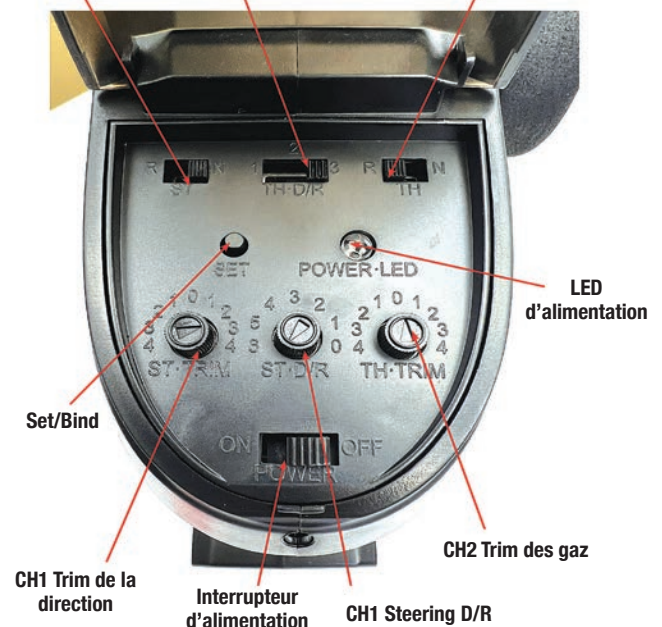

CHARGE

8. CHARGEMENT ET MONTAGE DE LA BATTERIE

- Stockez toujours votre voiture avec la batterie débranchée et enlevée
- Chargez toujours votre batterie en dehors de la voiture.
Le chargeur USB inclus met environ 4h pour charger la batterie 2000mAh lorsqu'elle est déchargée
- Pendant la charge la LED rouge reste allumée
- Lorsque la batterie est chargée, le LED verte restent allumées.
- La batterie peut légèrement chauffer pendant la charge, mais elle ne doit pas être chaude.
- Si la batterie est chaude, arrêtez immédiatement la charge. Débranchez alors la batterie du chargeur dès que la LED du chargeur devient vert

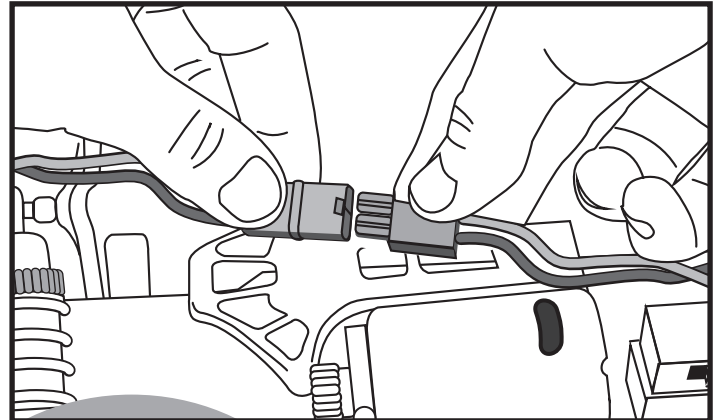
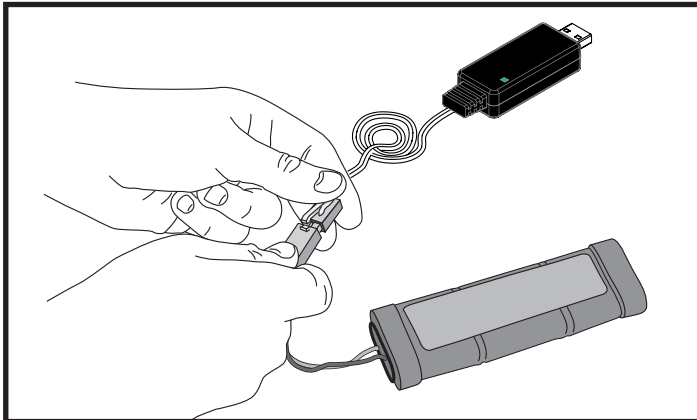

9. NOTES SUR L'UTILISATION DE LA BATTERIE

- Laissez toujours la batterie refroidir après son utilisation avant de la recharger.
- Inspectez toujours la batterie avant de la charger
- Tout fil dénudé, connecteur coupé ou fuite montre une mauvaise utilisation de la batterie
- N'essayez jamais de charger une batterie endommagée ou morte
- Ne démontez pas la batterie et/ou ne coupez pas les câbles
- Si la connectique de la batterie devient tellement chaude qu'elle fond, cela indique qu'il y a un problème important avec votre voiture, la transmission, les câbles de la batterie ou le contrôleur de vitesse.
Trouvez alors l'origine du problème et corrigez-le avant de monter une autre batterie
- Ne chargez jamais la batterie sans la surveiller en cas de surcharge, vous devez pouvoir monitorer la charge à tout moment
- Chargez la batterie éloignée de tout matériaux inflammables sur une surface non inflammable dans le cas où la batterie deviendrait trop chaude.

(Remarque: votre modèle est déjà lié de l'usine)



En route

Dépliez l'antenne passez sur ON la radio, tenez la voiture les roues en l'air, connectez les batteries puis allumez la voiture. Testez la voiture les roues en l'air pour vous assurer de son bon fonctionnement puis poser la voiture au sol et testez doucement son fonctionnement. Si la voiture ne va pas droit ajustez le trim de direction. Lors de la première utilisation accélérez doucement pour vous familiariser avec l'utilisation de la voiture.

S'IL VOUS PLAÎT NOTE

IMPORTANT : Veuillez noter que ce véhicule n'est pas étanche et ne doit pas être exécuté dans des conditions mouillées ou humides où l'humidité pourrait pénétrer dans l'électronique.

Arrêt du modèle

Eteignez l'interrupteur du récepteur (voiture), éteignez ensuite l'interrupteur de la radio-commande puis repliez l'antenne. Débranchez ensuite les batteries et retirez celles-ci de la voiture.

Laissez les batteries refroidir avant des les recharger. Si vous possédez une seconde batterie déjà chargée, laissez le véhicule refroidir quelques minutes avant d'installer cette deuxième batterie.

Entretien.

Vérifiez souvent que les vis ne manquent pas ou ne sont pas desserrées. Utilisez Threadlocker pour tout remplacement de vis en métal. Vérifiez que les pièces rotatives sont libres (herbe, pierre, etc.). Si ces pièces ne sont pas libres, cela peut les endommager ou usent le moteur ou l'entraînement. Retirez les roues et vérifiez que rien n'a glissé derrière l'hexagone de roue et empêche une bonne liberté de transmission. Les amortisseurs s'useront plus rapidement si vous roulez conditions poussiéreuses, remplacez l'huile ainsi que les joints pour maintenir un bon amortissement. Vérifiez souvent que les vis ne manquent pas ou ne sont pas desserrées. Utilisez Threadlocker pour tout remplacement de vis en métal. Vérifiez que les pièces rotatives sont libres (herbe, pierre, etc.). Si ces pièces ne sont pas libres, cela peut les endommager ou usent le moteur ou l'entraînement. Retirez les roues et vérifiez que rien n'a glissé derrière l'hexagone de roue et empêche une bonne liberté de transmission. Les amortisseurs s'useront plus rapidement si vous roulez conditions poussiéreuses, remplacez l'huile ainsi que les joints pour maintenir un bon amortissement.

Solutions aux problèmes:

Durée de roulage très courte:	Vitesse lente:	Le moteur ou le variateur surchauffe:	Le moteur tourne mais la voiture n'avance pas:	Une portée courte ou aucun contrôle de la voiture:
Les batteries sont endommagées ou mal chargées.	Le moteur est sale ou les charbons usés.	La transmission n'est pas libre	La transmission est abîmée.	Les piles de la télécommande sont vides, les batteries de la voiture sont vides, l'antenne n'est pas dépliée, un fil est débranché, l'électronique est endommagée.
Le moteur est sale ou les charbons usés.		Le moteur est endommagé.	Le slipper est desserré, un cardant est cassé ou manquant.	

Garantie

De part la nature de ce produit et l'utilisation potentiel, FTX garanti qu'il n'a pas défaut lorsque le modèle est neuf. FTX s'engage à réparer ou remplacer les composants défectueux gratuitement dans un délai de 30 jours à compter de la date d'achat. Cette garantie ne couvre pas l'usure normale, l'accident ou l'impact, les modifications, les dégâts des eaux (appareil n'étant pas étanche) le manque d'entretien ou de dommages causés par une mauvaise utilisation. La preuve de la date d'achat sera nécessaire lors des réclamations de garantie.

Instructions pour la mise au rebut.

Ce produit ne doit pas être jeté avec les autres déchets. L'utilisateur doit le déposer dans un point de collecte et de recyclage des déchets. Pour plus d'informations sur l'endroit où vous pouvez déposer vos déchets, s'il vous plaît contacter votre municipalité, ou bien où vous avez acheté le produit.



CML DISTRIBUTION, SAXON HOUSE, SAXON BUSINESS PARK, HANBURY ROAD, BROMSGROVE, B60 4AD.

WEE/GB4215VX





DRIVE GEAR SET

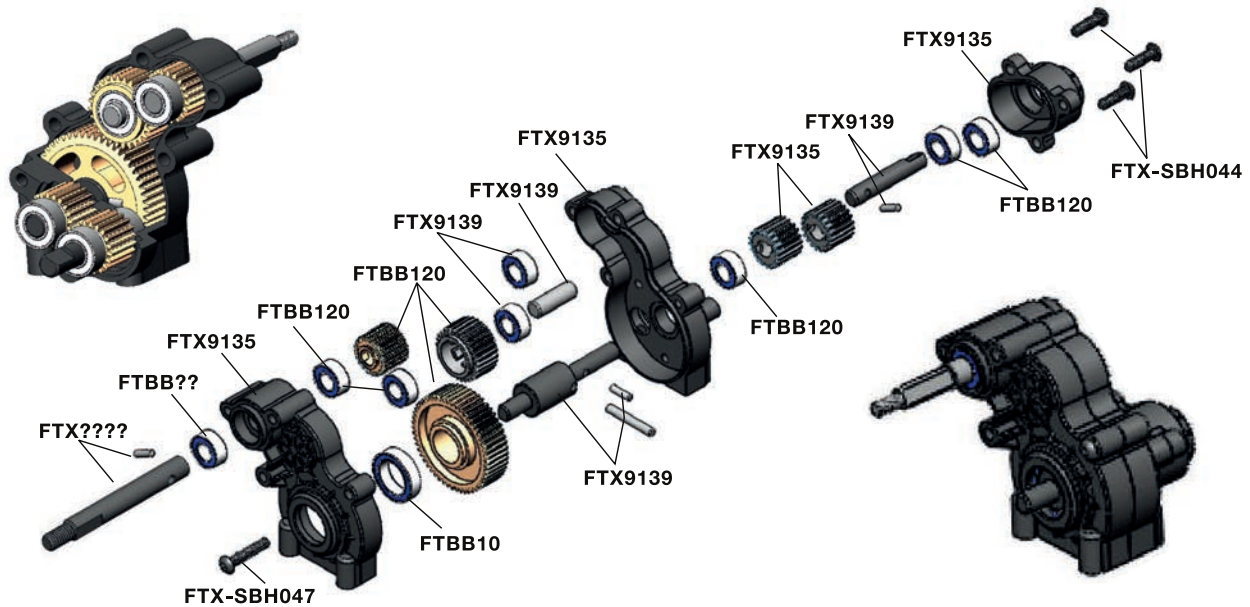

TRANSMISSION ASSEMBLY

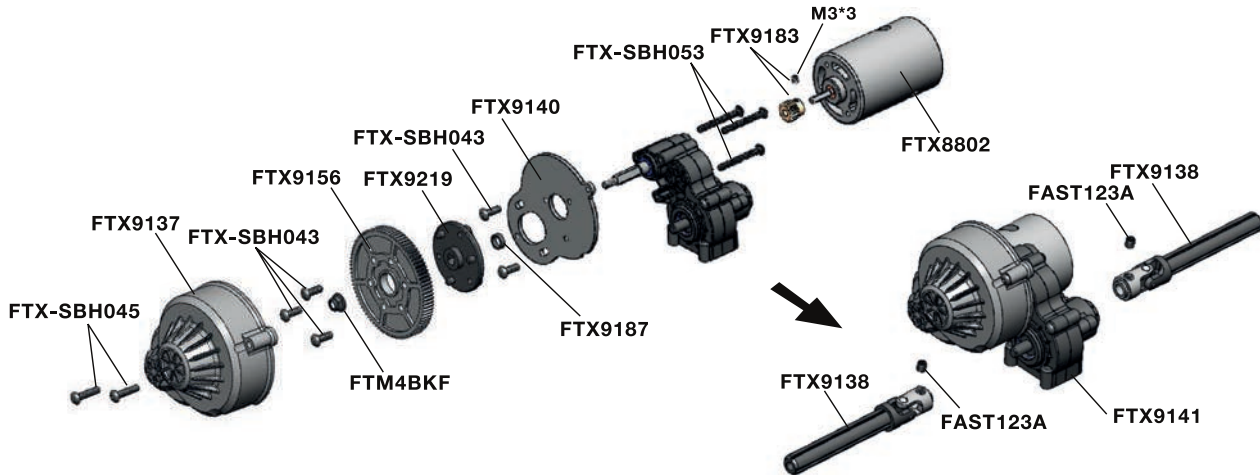

SPARE PARTS

<p>FTX9135</p> <p>Distribution Housing</p>	<p>FTX9136</p> <p>(20T*3P+28T+53T) Gear Set</p>	<p>FTX9137</p> <p>Motor Cover</p>	<p>FTX9138</p> <p>Univrsal Drive Dogbone</p>	<p>FTX9139</p> <p>Gear Shaft Set</p>	<p>FTBB120</p> <p>Ø10*Ø5*Ø4 Ball Bearing</p>	<p>FTBB10</p> <p>Ø15*Ø10*4mm Ball Bearing</p>
<p>FTX9183</p> <p>Motor Gear(14T)</p>	<p>FTX8802</p> <p>(RC540 -20T)</p>	<p>FTX9140</p> <p>Motor Mount</p>	<p>FTX9156</p> <p>Main Gear set (87T)</p>	<p>FTX9219</p> <p>Gear Mount</p>	<p>FTM4BKF</p> <p>Flange Nut M4</p>	<p>FAST123A</p> <p>Grub Hex Screw M4*4</p>
<p>FTX-SBH043</p> <p>2.0</p> <p>Button Head 3*8</p>	<p>FTX-SBH044</p> <p>2.0</p> <p>Button Head 3*10</p>	<p>FTX-SBH045</p> <p>2.0</p> <p>Button Head 3*12</p>	<p>FTX-SBH047</p> <p>2.0</p> <p>Button Head 3*15</p>	<p>FTX-SBH053</p> <p>2.0</p> <p>Button Head 3*25</p>	<p>FTX9157</p> <p>Gasket (6.8*5*2)</p>	<p>FTX9141</p> <p>Transmission</p>



FRONT DRIVE SYSTEM ASSEMBLY

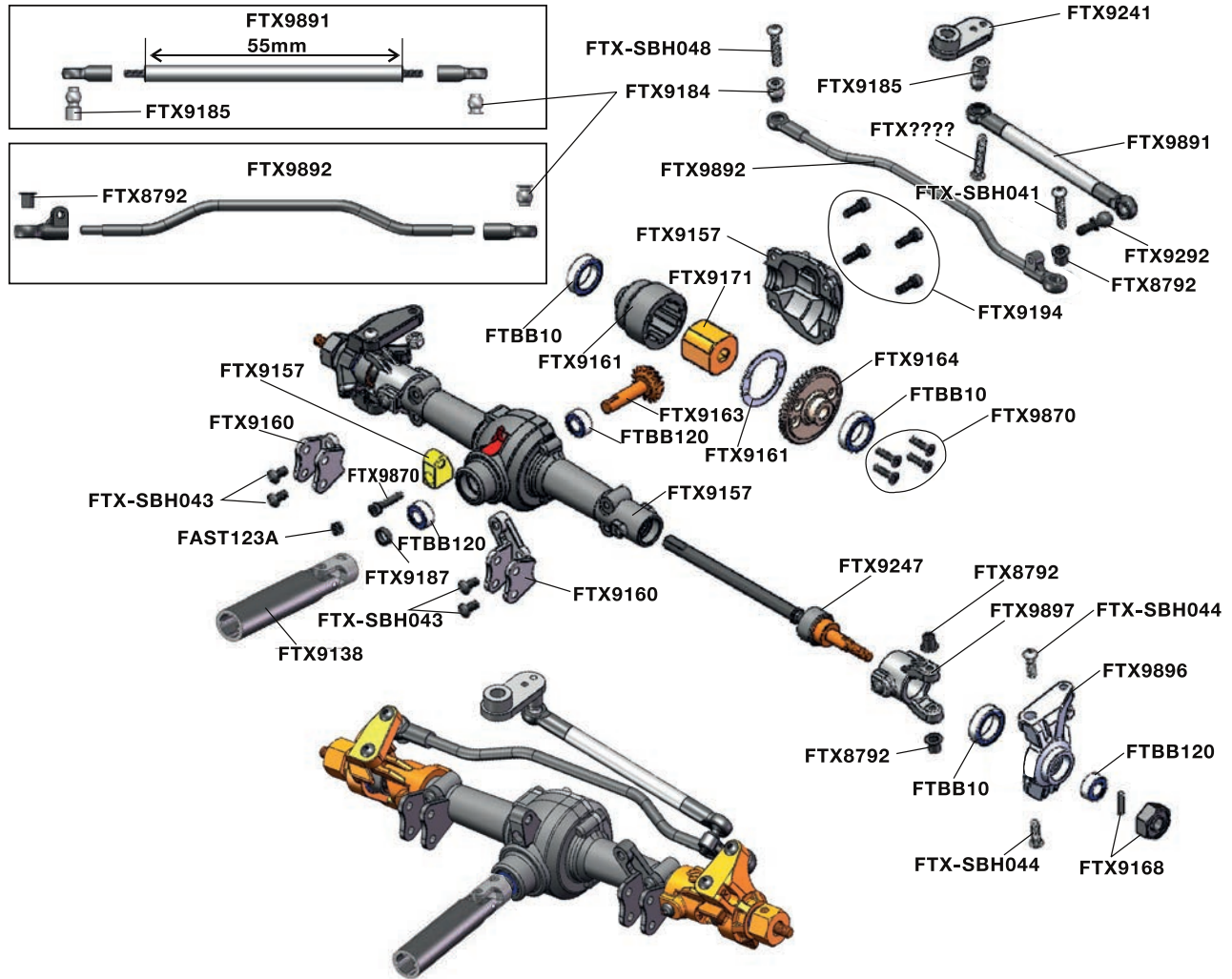

FRONT SUSPENSION ASSEMBLY

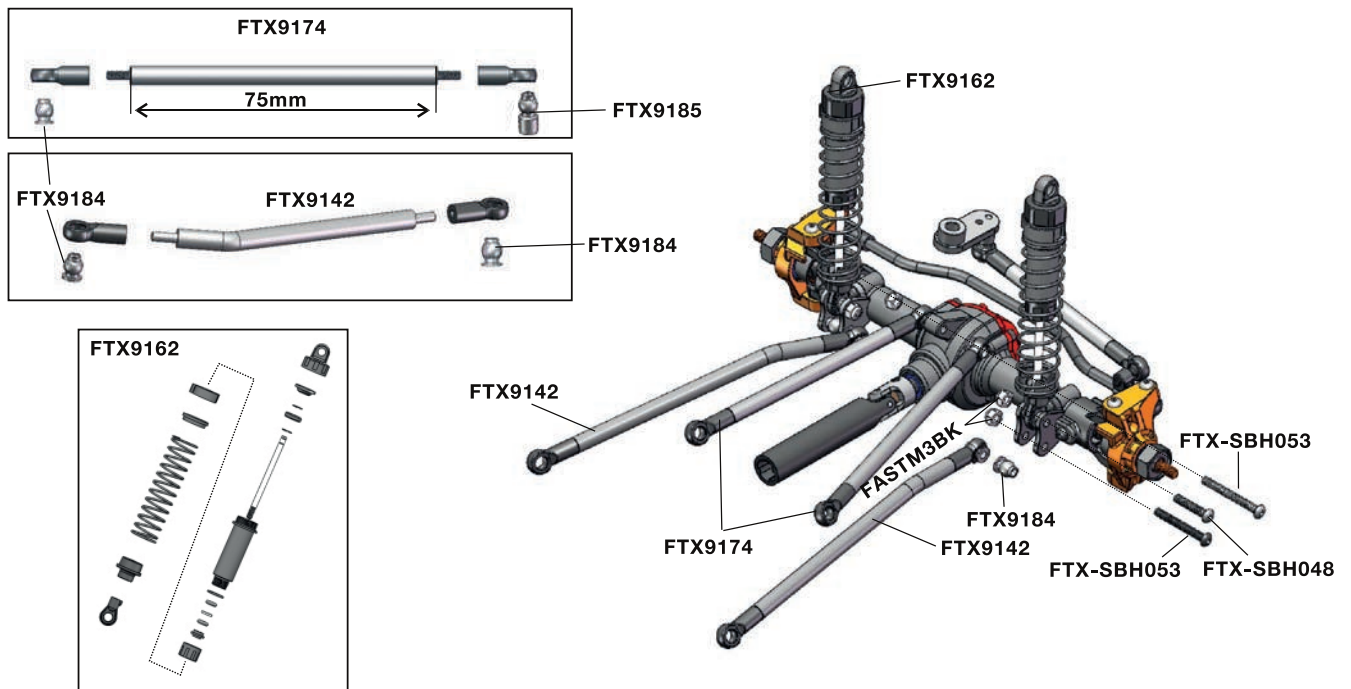



REAR DRIVE SYSTEM ASSEMBLY

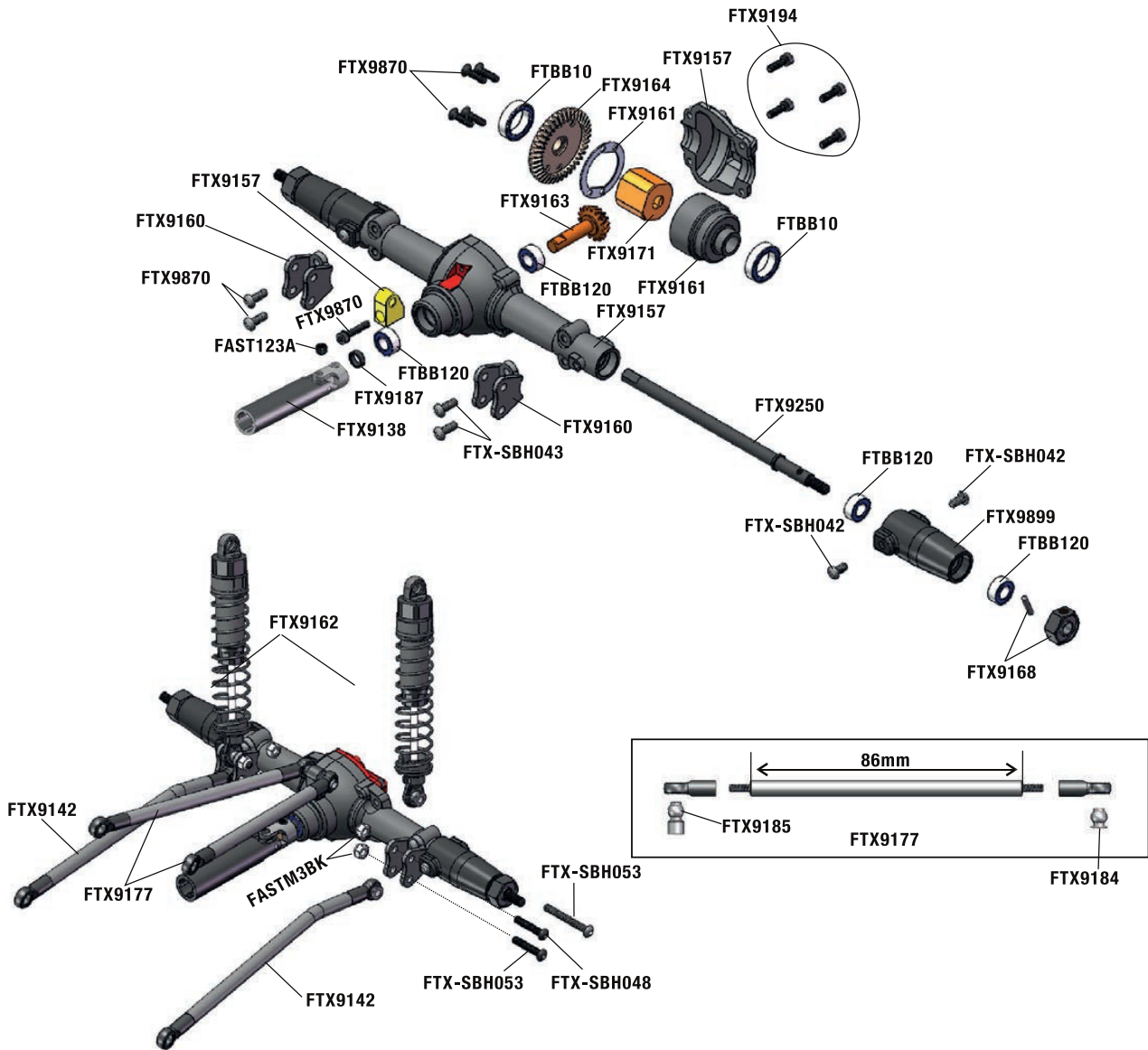

SPARE PARTS

<p>FTX9138</p>  <p>Univrsal Drive Dogbone</p>	<p>FTBB120</p>  <p>Ø 15*Ø 10*4mm Ball Bearing</p>	<p>FTBB10</p>  <p>Ø10*Ø5*04mm Ball Bearing</p>	<p>FTX9157</p>  <p>—2.5*11 Gear Box/Housing</p>	<p>FTX9247</p>  <p>CVD Drive Shaft</p>
<p>FTX9250</p>  <p>Rear Shaft</p>	<p>FTX9161</p>  <p>Differential Box</p>	<p>FTX9163</p>  <p>Drive Gear</p>	<p>FTX9164</p>  <p>Crown Gear (40T)</p>	<p>FTX9171</p>  <p>Solid Axle Hub</p>











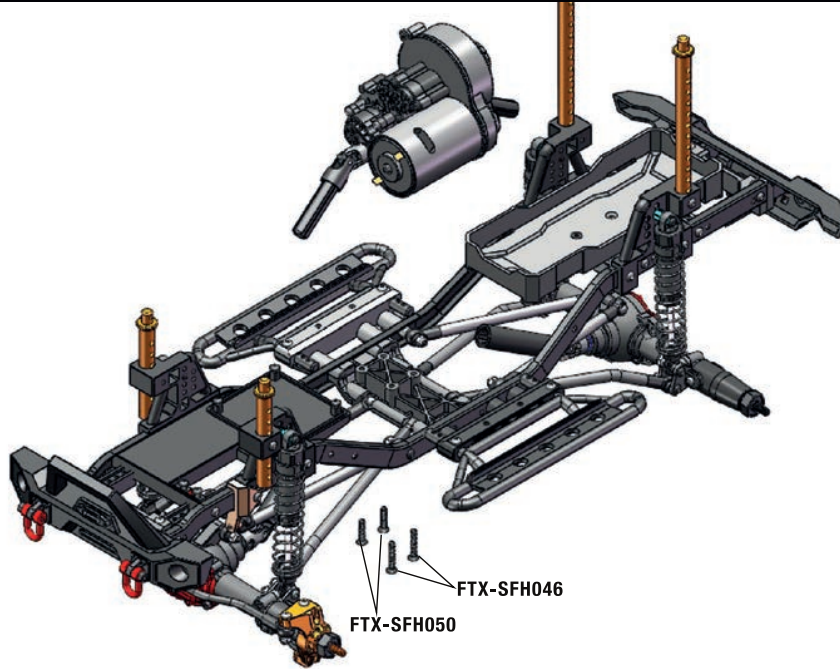



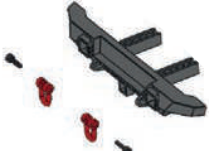

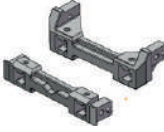



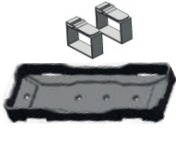



SPARE PARTS

FTX9897 Steering Hubs(L/R)	FTX9896 Steering Hub Carriers(L/R)	FTX8792 King Pin Bushing	FTX9187 Gasket	FTX9168 Wheel Hex
FTX9160 Link Mount Sct	FTX9162 Shock Absorbers	FTX9177 Rear Upper Link (86 mm)	FTX9174 Front Upper Link (75mm)	FTX9142 Lower Link (F/R)
FTX9892 Steering Link	FTX9891 Servo link	FTX9899 Rear Straight Axle	FTX9184 Ball Stand 1 Ø5.9	FTX9185 Ball Stand 2 Ø5.9
FTX9241 Servo Horn	FAST123A Grub Hex Screw M4*4	FTX9292 Ball Stand 0ø.9	FTX-SBH043 Button Head 3*8	FTX-SBH044 Button Head 3*10
FTX-SBH053 Button Head 3*25	FTX-SBH048 Button Head 3*16	FTX-SBH042 Button Head 3*6	FTX-SFH024 Flat Head 2.5*10	FTX9870 Cap Head 2.5*1 1
FTX9194 Cap Head 2.5*8	FASTM3BK Nylon Nut M3			



TRANSFER CASE ASSEMBLY



FTX9850  Front Bumper	FTX9849  Rear Bumper	FTX9153  Boad Post (F/R)	FTX9134  Bumper Mount	FTX9158  Servo/ESC/ Receiver Mount
FTX9151  Chassis Plate	FTX9152  Body Plates(F/R)	FTX9150  Battery Box Mounts	FTX9169  Battery Tray+Batter Strap	FTX9231  Foot Plate Set
FTX-SBH043  Button Head 3*8	FTX-SBH044  Button Head 3*10	FTX9173  Panhard Bar (51.8mm)	FTX-SBH045  Button Head 3*12	FTX9180  Chassis Rails
FTX-SBH042  Button Head 3*6	FTX-SBH046  Button Head 3*14	FTX-SCH045  Column Head 3*12	FTX-SBH049  Button Head 3*18	FTX-SBH050  Button Head 3*20
FTX-SFH043  Flat Head 3*8	FTX-SFH046  Flat Head 3*14	FTX-SFH050  Flat Head 3*20		



ASSEMBLE ELECTRIC SYSTEM

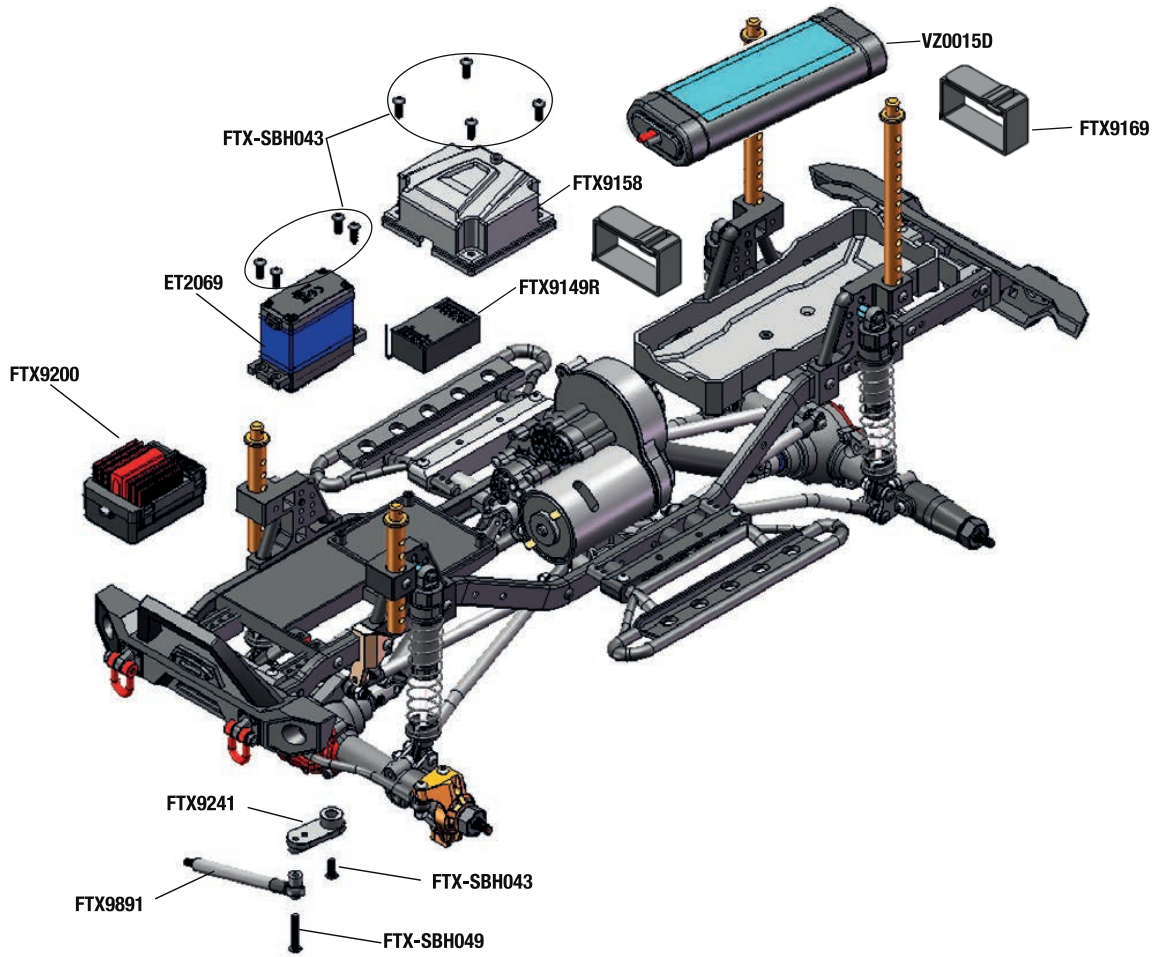



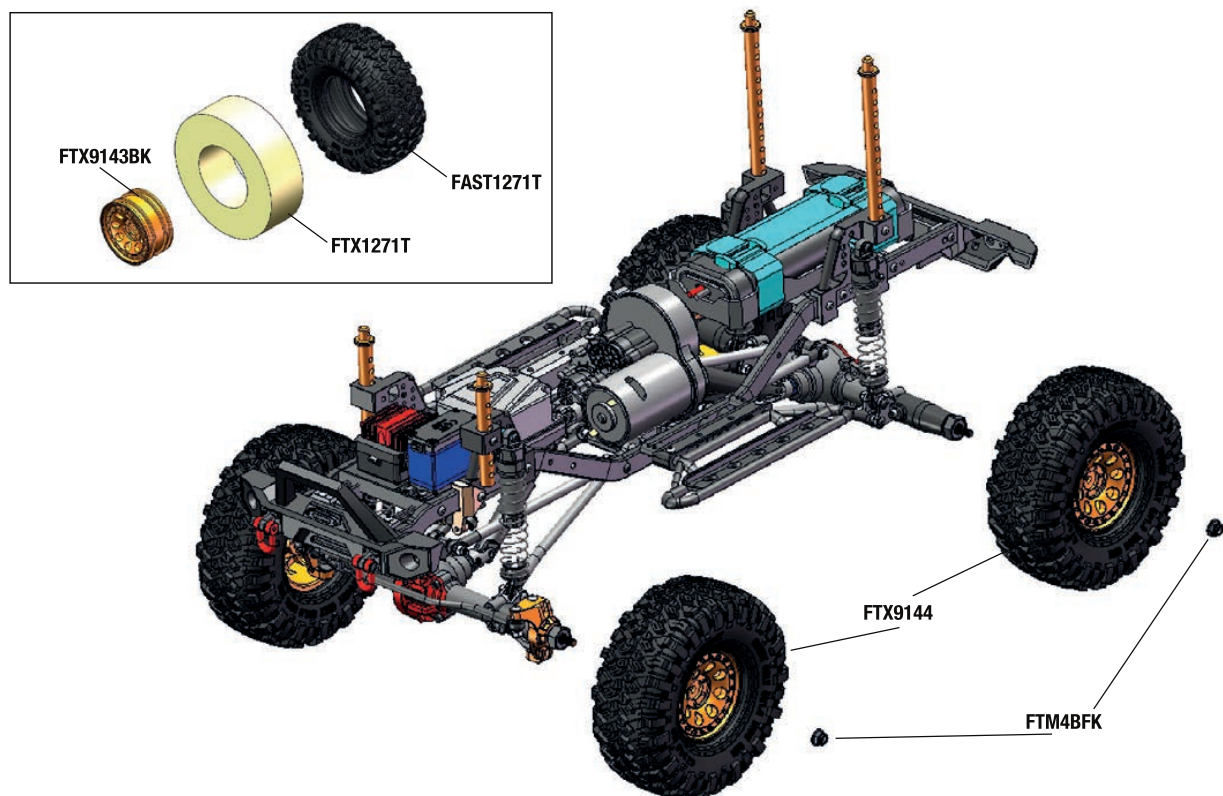









WHEELS



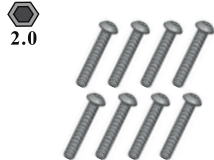

SPART PARTS







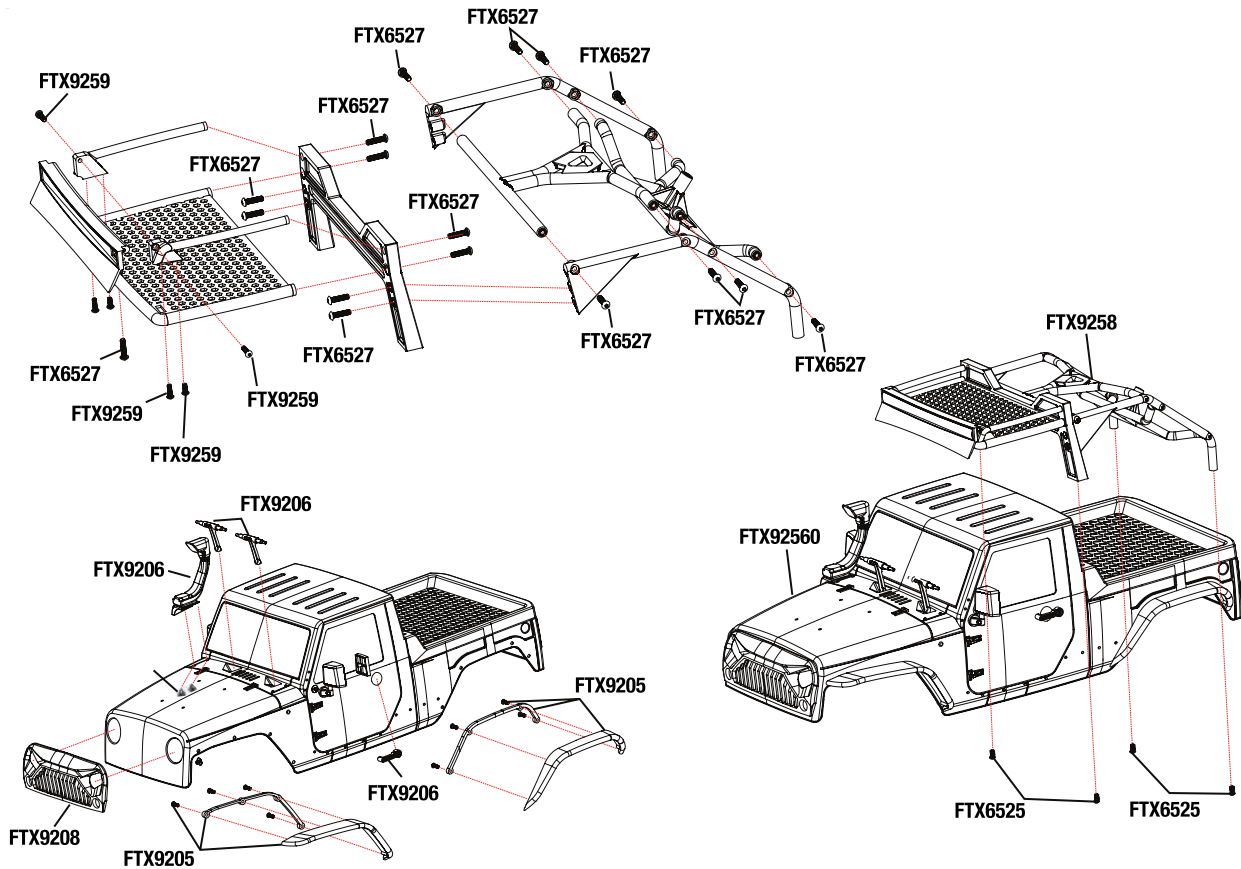

FTX9149T	FTX9149R	ET2069	VZ0015D	FTX9200
 <p>Radio</p>	 <p>Receiver</p>	 <p>Servo-15KG</p>	 <p>Battery (7.2v2000mAh)</p>	 <p>ESC -40A</p>
FTX9241	FTX9143BK	FAST1271T	FTX9144	FTX-SBH049
 <p>Servo Horn</p>	 <p>Wheel Rim</p>	 <p>Tire W/Foam</p>	 <p>Wheel Complete</p>	 <p>Button Head 3*18</p>
FTX-SBH043	FTM4BFK	FTX9891		
 <p>Flat Head 3*8</p>	 <p>Flange M4 Lock Nut</p>	 <p>Servo link</p>		

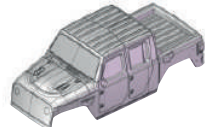

BODY

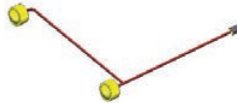

SPARE PARTS

<p>PVC Body</p> <p>Complete body with Moulded frame FTX9145BK Black FTX9146R Red</p> 	<p>PVC Body</p> <p>FTX9146BK - Black FTX9146R - Red FTX9146C - Clear</p> 	<p>FTX9208N</p>  <p>Air Grill(New)</p>	<p>FT-SBH003</p> <p>1.5</p>  <p>Button Head 2*6</p>	<p>FTX-SBH040</p> <p>2.0</p>  <p>Button Head 3*4</p>
<p>FTX9205</p>  <p>2.5*10 16Pcs</p> <p>Wheel Eyebrow</p>	<p>FTX9206</p>  <p>Body Shell Parts</p>	<p>FTX9148</p>  <p>LED Body Shell Light</p>	<p>FTX9871</p> <p>2.0</p>  <p>Flange Head Screws3*4</p>	
<p>FTX-SBH024</p> <p>1.5</p>  <p>Button Head 2.5*10</p>				



UPGRADEABLE OPTIONS

<p>FTX9923 – Caster Mounts</p> 	<p>FTX9220 – Shock Absorber</p> 	<p>FTX9239 – Straight Axle Mount (Alum.)</p> 	<p>Portal Axle Box Cover (AL.) FTX9221-S (Silver) FTX9221 (Red)</p> 	<p>FTX9224 – Mount for Link (Alum.)</p> 
<p>FTX9227 Rear Straight Axle Cover (AL.)</p> 	<p>FTX9299 - Steering Mount</p> 	<p>FTX9226 Sway Bar Upper Mount (AL.)</p> 	<p>FTX9225 Sway Bar Lower Mount (AL.)</p> 	<p>FTX9237 CVD Drive Axle</p> 
<p>FTX9922 - Alloy Wheel Weigh Set 132g</p> 	<p>FTX9920BK Wheel (AL.)</p> 	<p>FTX9221BK Wheel (AL.)</p> 	<p>FTX9261 - Front Bumper (AL.)</p> 	<p>FTX9262 -Rear Bumper (AL.)</p> 
<p>FTX9228 Front/Rear body plates (AL.)</p> 	<p>FTX9234 Front Bumper (AL.)</p> 	<p>FTX9203 – Light For Rear/ Front Bumper</p> 	<p>FTX9260 – LED Light Bar for Roll Cage</p> 	<p>FAST1270T – Tyre W/Foam</p> 
<p>FTX9242T – Snow/sand Replacement Tracks (pr)</p> 	<p>FTX9242F - Front Snow WheelTrack</p> 	<p>FTX9242R – Rear Snow WheelTrack</p> 		



NOTES:

A series of horizontal dotted lines for taking notes, filling the majority of the page.



NOTES:

A series of horizontal dotted lines for taking notes, spanning the width of the page.



OUTBACK
FURY 2.0



www.ftx-rc.com



FTX is an exclusive brand of CML Distribution, Saxon House, Saxon Business Park,
Hanbury Road, Bromsgrove, Worcestershire, B60 4AD England.
E-mail: info@ftx-rc.com