

1/10TH SCALE 4WD ELECTRIC POWERED
READY-TO-RUN OFF ROAD RACING BUGGY

VANTAGE2.0



INSTRUCTION BOOK AND COMPONENT LISTING

ENGLISH INSTRUCTIONS – PAGE 2
FRANÇAIS INSTRUCTIONS – PAGE 11



www.ftx-rc.com





FTX Vantage 2.0 1/10th Scale 4WD Electric Powered Ready-To-Run Off Road Racing Buggy

Congratulations on your purchase of the FTX 'Vantage 2.0' electric off road car.

This 1/10th scale model has been factory assembled and all electrics installed and set up to make it the easiest possible introduction to the sport of driving RC cars.

WARNING: Read the ENTIRE instruction manual to become familiar with the features of the product before operating. Failure to operate the product correctly can result in damage to the product, personal property and cause serious injury. This is NOT a toy and must be operated with caution and common sense. Failure to operate this product in a safe and responsible manner could result in damage, injury or damage to other property. This product is not intended for use by children without direct adult supervision. It is essential to read and follow all the instructions and warnings in the manual, prior to assembly, set-up or use, in order to operate correctly and avoid damage or serious injury.

Safety Precautions and Warnings

- You are responsible for operating this model such that it does not endanger yourself and others, or result in damage to the product or the property of others.
- This model is controlled by a radio which is possibly subject to interference which can cause momentary loss of control so it is advisable to always keep a safe distance to avoid collisions or injury.
- Age Recommendation: 14 years or over. This is not a toy. This product is not intended for use by children without direct adult supervision.

Carefully follow these directions and warnings, plus those of any additional equipment associated with the use of this model, chargers, ESC and motors, radio etc.

- Never operate your model with low transmitter batteries.
- Always operate your model in an open area away from cars, traffic or people.
- Never operate the model in the street or in populated areas.
- Always keep the vehicle in direct line of sight, you cannot control what you cannot see!
- Keep all chemicals, small parts and anything electrical out of the reach of children.
- Although splash-proof the car and electronics are not designed to be subjected to extended moisture exposure or submersion. To do so will result in permanent damage.
- Avoid injury from high speed rotating parts, gears and axles etc.
- Novices should seek advice from more experienced people to operate the model correctly and meet its performance potential.
- Exercise caution when using tools and sharp instruments.
- Do not put fingers or any objects inside rotating and moving parts.
- Take care when carrying out repairs or maintenance as some parts may be sharp.
- Do NOT touch equipment such as the motor, electronic speed control and battery, immediately after using your model because they can generate high temperatures.
- Always turn on your transmitter before you turn on the receiver in the car. Always turn off the receiver before turning your transmitter off.
- Keep the wheels of the model off the ground, and keep your hands away from the wheels when checking the operation of the radio equipment.
- Prolong motor life by preventing overheat conditions. Undue motor wear can result from frequent turns, rapid change of direction forwards/backwards, continuous stop/starts, pushing/pulling objects, driving in deep sand and tall grass, or driving continuously up hill.

Contents:

FTX Vantage 2.0 RTR Buggy
Transmitter: 2.4ghz Steerwheel
Charger: USB 500mA Charger
Battery: 1800mAH 7.2v





REQUIRED EQUIPMENT FOR OPERATION

1. Tools required for building and maintenance:

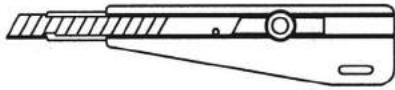

● Hobby knife

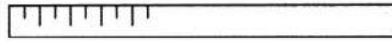

● Precision ruler

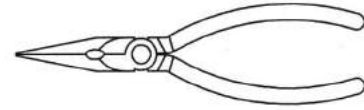

● Needle nose pliers

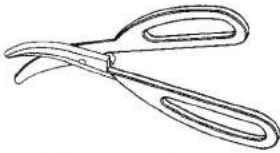

● Lexan scissors

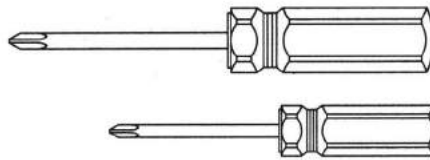

● Flat and Philips screwdriver

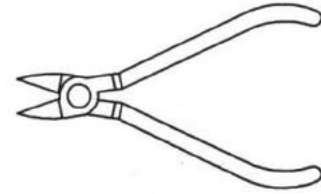

● Wire cutters

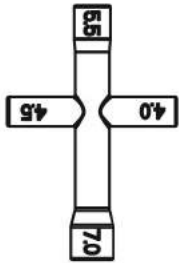

● Cross wrench

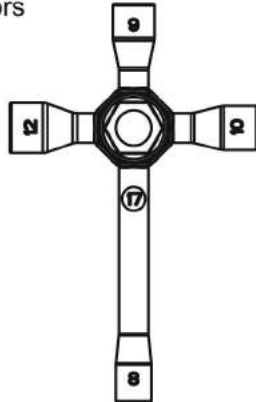

● Cross wrench



● CA glue&rubber cement



● Thread locking compound

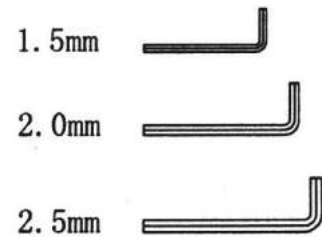

● Hex wrench

WARNING!

Do not use a power screw driver to install screws into nylon or plastic materials. The fast locking may heat up the screws being installed that may break the molded parts or strip the threads during installation.

2. Additional items needed for operation:

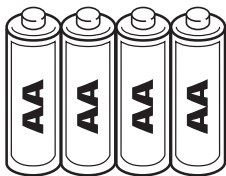

4 pcs AA Alkaline Batteries

IMPORTANT!

Check that all screws and nuts are tight before each use.

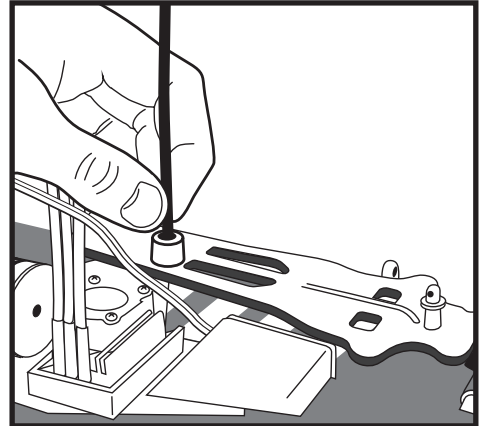
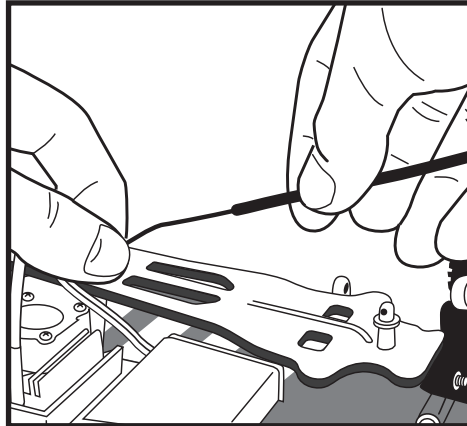
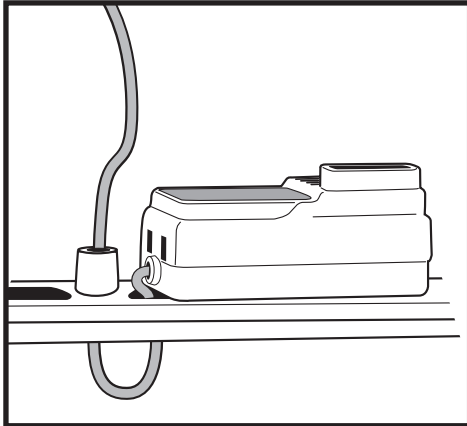

Aerial Assembly.

Uncoil the aerial wire carefully so as not to kink or knot it in anyway, and first be sure to insert the wire up through the top chassis aerial mount hole from below. Pull the rubber tube cap off the aerial tube and push the wire all the way through the aerial tube until the first 5mm of wire shows out of the other end. Fold the wire down over the end of the tube and be sure to insert the rubber tube cap so that it traps the protruding wire to hold it firmly in the tube. Push Aerial tube into mounting hole in upper chassis until firmly seated. Bundle any excess aerial wire neatly away from rotating components on the chassis.

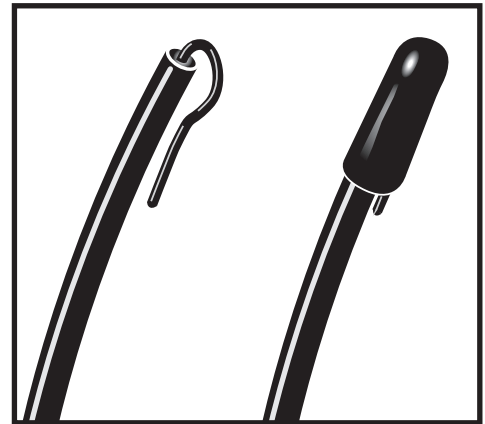

Charging/Installing the Battery.

Always store your model with the battery pack unplugged and removed. Always charge your battery away from the vehicle. The included USB charger will take approximately 3.5 hours to charge a discharged 1800mAh battery.

- When charging the Red LED will be solid.
- When the battery is fully charged the Green LED will be solid.

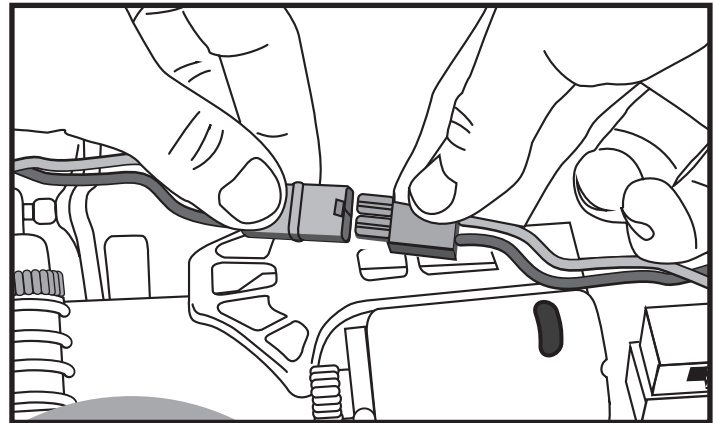
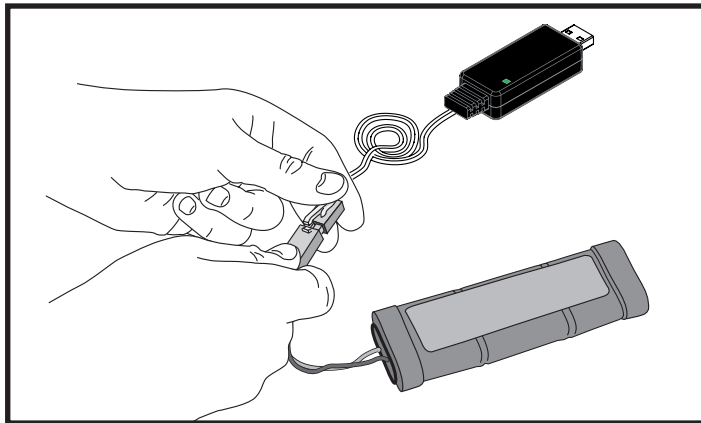

To install a charged battery, remove the body clips and remove the bodyshell. Remove the battery retainer clips, insert battery and reinstall retainer with the flat side facing the battery and re-insert clips. When connecting battery and turning car on, ensure it is off the ground, with wheels away from objects.

IMPORTANT! Notes on Battery use:

Always allow the battery cool after use, before recharging.

Always inspect the battery before charging.

Any bare wires, split heat shrink or leakage is a sure sign of abuse.

Never attempt to charge dead or damaged batteries.

Do not disassemble the battery or cut the connector wires.

If the battery connector gets hot enough to melt there is most likely a serious problem with your model, drive line, battery wires or speed controller. Find and correct the problem before installing another charged battery pack.

NEVER charge the battery unattended in case of overcharging, you need to be able to monitor the battery during charging

Charge away from flammable objects and on a non-flammable surface in case the battery becomes too hot.



ETRONIX

PULSE

EX3G 2.4GHz FHSS RADIO SYSTEM

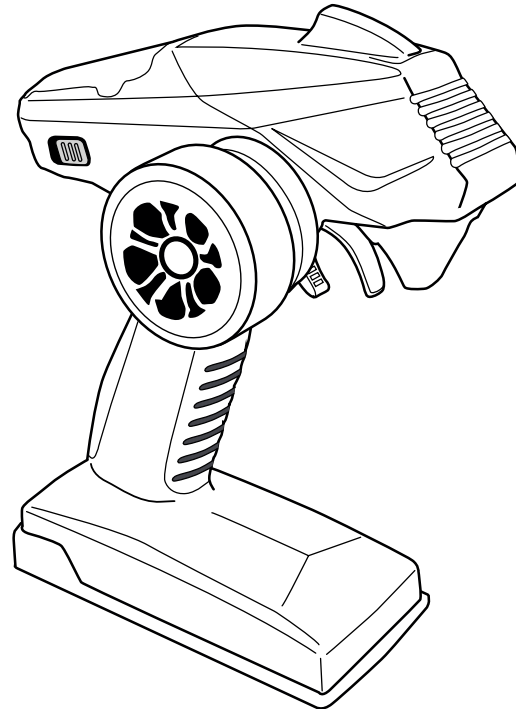

SAFETY PRECAUTIONS

This radio system is designed for use in high quality radio-controlled models. To ensure your safety and that of other people around you, please follow these guidelines carefully.

1. Always follow local laws or regulations regarding the operation of radio-controlled models.
2. Always turn on the transmitter first, followed by the receiver. When finished, turn off the receiver first followed by the transmitter.
3. Please do not attempt to modify this product. Etronix cannot be held responsible for any damage that might occur to the product as a result of an unauthorised modification.
4. Please make sure the batteries in the transmitter and those used to power the receiver have sufficient power before using your model. Using batteries with insufficient power will reduce the range of the radio and may result in a loss of control.
5. Make sure that any servos and/or ESC are securely connected to the receiver at all times.
6. Please keep the radio system away from moisture, heat, fire and sources of electronic interference at all times.
7. Please do not make any adjustments to transmitter settings while the model is in motion. Always wait until the model is standing still before making any adjustments to the transmitter settings.
8. The low voltage warning will activate when the battery in the transmitter is below 4.4v. The LED on the transmitter will flash blue and will be accompanied by a beeping sound. Please stop using your model immediately if the low voltage warning activates to prevent loss of control.
9. Etronix will not be held liable or responsible for any damages caused by the operation of your radio-controlled model.

QUICK OPERATION GUIDE

Transmitter/Receiver Binding (Note: Your model is already bound from the factory)

1. Turn on the transmitter while holding down the '3CH' button located on the hand grip. Release the button when the LED on the transmitter starts flashing blue and you hear a beeping noise. The transmitter is now in it's binding mode.
2. Turn on the receiver. The LED on the receiver will be flashing green slowly. Place the transmitter next to the receiver then press the 'Bind' button on the receiver until you see the green LED on the receiver flash rapidly then return to a slow flash. Release the button on the receiver.
3. Turn the transmitter off then switch it back on again; the LED on the receiver should become solid green. The binding process is now complete.



Failsafe Setup

1. Put the throttle trigger to the desired failsafe position (we advise 50% brake for nitro models and neutral for electric models) then press the 'F/S' button on the receiver until the LED on the receiver flashes green then returns to solid. Once the LED is solid the failsafe has been set. The failsafe position needs to be reset every time the transmitter and receiver have been through the binding process.

2. The failsafe will return Channel 2 to the set position in the event of signal loss from the transmitter or in the event of low battery voltage supply to the receiver. If battery power to the receiver is lost completely then the failsafe cannot operate.

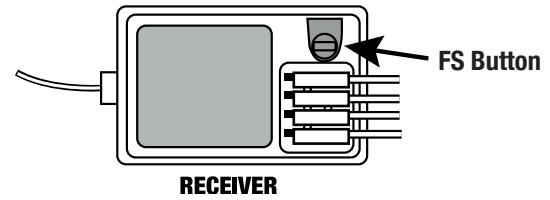

Receiver Connections

1. The steering servo should be connected to Channel 1 of the receiver, with the throttle servo or ESC connected to Channel 2.
2. Channel 3 of the receiver operates as a two-position switch, so would normally be used to control a forward and reverse gearbox (if available) on a nitro powered model, or a Hi/Low ratio transmission (if available). Please consult the manufacturer of your model for details of option parts available.

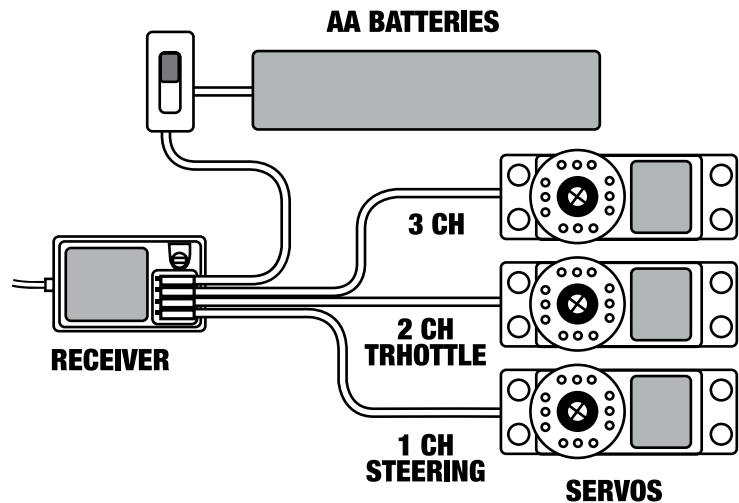

Aux Channel (3CH) :

Press the 3ch one time to activate it and press it again to return the servo back to neutral position.

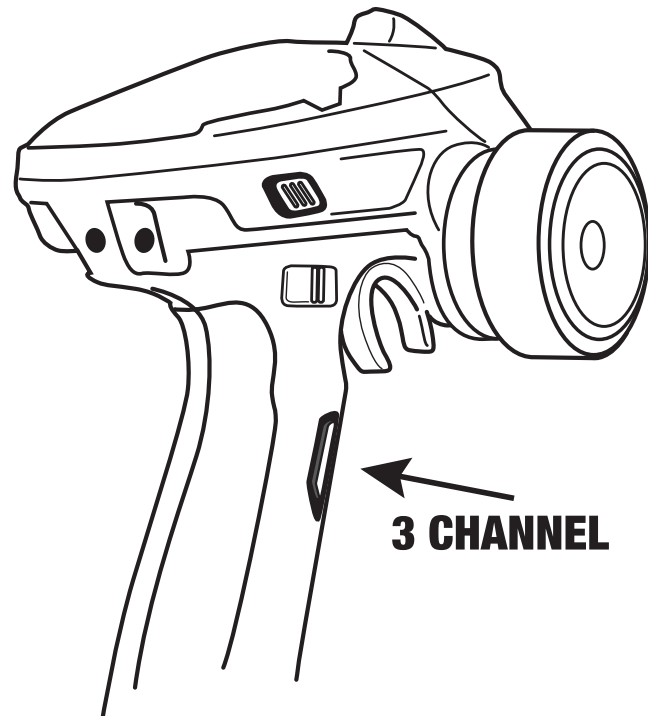



First time set up the Brush ESC

1 Connection Diagram

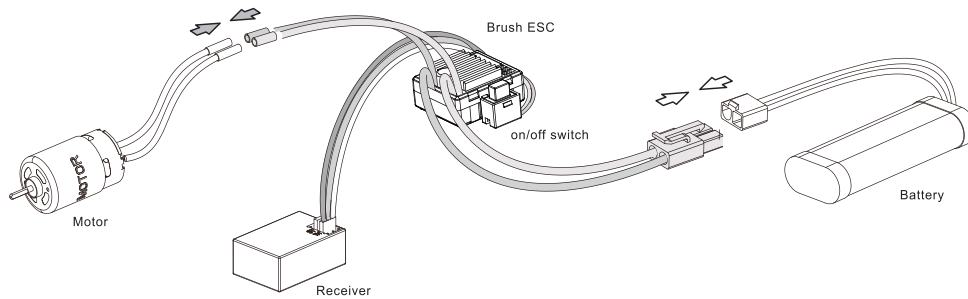

1. This Brush esc is not polarity protected. Please pay attention when you plug in. Make sure the battery polarity is correctly plugged into the ESC or we will not responsible for any loss.
2. Just change two motor wire if you find the rotation is wrong direction

Product Specification

Model	TB-60025	TB-60060
Forward: Continues/Peak current	25A/100A	60A/360A
Backward: Continues/Peak current	25A/100A	30A/180A
Battery type	1-2s Li-Po, 4-6cells Ni-mh	2-3s Li-Po, 5-9cells Ni-mh
Type of Model	1/18, 1/24 onroad, offroad, bigfoot, Truggy	1/10, 1/12, 1/16 onroad, offroad, shortcourse, buggy, crawler, tank
Motor in Turn (T)	1s Lipo(Only support Lipo if 1cell is used)	540,550motor ≥12T or below 30000rpm@7.2v
	2s Lipo or 6cells Nimh	540,550motor ≥18T or below 30000rpm@7.2v
interal resistance	280,370,380 motor rpm below 30000rpm@7.2v	CW:0.001Ω CCW:0.002Ω
BEC Output Voltage	1A/6v (Linear regulation)	3A/6v (switching regulation)
Size/ Weight	32.2*25.3*16.9mm/23.5g	34.5*30.2*18.7mm/39g
Mode	Boat, Forward/Backward, Crawler	Boat, Forward/Backward, Crawler

2 Throttle setting

Turn on the transmitter, set Throttle D/R, EPA, ATL to 100%. Trim of throttle channel set to neutral. We strongly recommend to turn on failsafe function to cut off or neutral.

Turn on the ESC and set throttle trigger to neutral position. ESC will automatically self detection and calibration within 3s. Successful setting will sound "beep"

Battery type selection sound with "Beep"	LED indication when operation
•Short one beep, Nimh battery	•LED off when throttle trigger at neutral position
•short two beep, 2s Lipo	•LED flash when throttle is not at full speed
•short three beep, 3s Lipo	•LED solid on when throttle is at full speed
•Long one beep, Normal operation.	

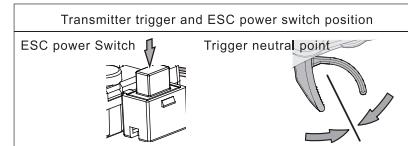

Mode and battery setting

Mode setting:

1. Mode and Battery are set by Jumper Pin

Setting method: Use Tweezers to select mode and battery type as illustration

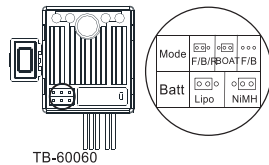

Setting:

1. Model Mode: Forward/Brake/Reverse, Boat, Crawler, Defaulted F/B/R

Meaning of Forward/Brake/Reverse is your model go forward then brake and reverse. When you going forward, pull trigger once is brake then pull once more is reverse. It prevents sudden reverse if pull the trigger

Boat mode only has forward and reverse without brake.

*Crawler mode: Forward and reverse with drag brake

2. Factory default battery setting: Li-po

(Factory default mode setting: Forward/Brake/Reverse)

Protection Features

1. Battery Protection: when ESC detect the battery level lower then the preset value. It enters protection mode(normally there two steps of protection. First is lower the power output. Second is cutoff the power
2. Temperature protection: when internal temperature higher than 100°C. It will lower the motor output to prevent the car suddenly stop. LED flashing. It recover to normal when temperature below 80°C when boat mode is selected. The power will be cut to half when voltage low level. LED flashing rapidly. Please drive back to the shore as soon as you can

1s Lipo	2s Lipo	3s Lipo	5-9 cells Nimh
voltage drop to 3.2v, LED flash rapidly, power cut off	voltage drop to 6.5v, LED flash rapidly, power cut to half, when drop to 6v, LED flash slowly power cut off	voltage drop to 9.5v, LED flash rapidly, power cut to half, when drop to 9.0v, LED flash slowly power cut off	voltage drop to 4.5v, power cut to half, when drop to 4.0v power cut off



RUNNING YOUR CAR

1. TURNING ON THE RECEIVER OF YOUR CAR

The ESC Receiver switch is located under the bodyshell of the model. Switch on the ESC/Receiver Switch as shown in the picture.

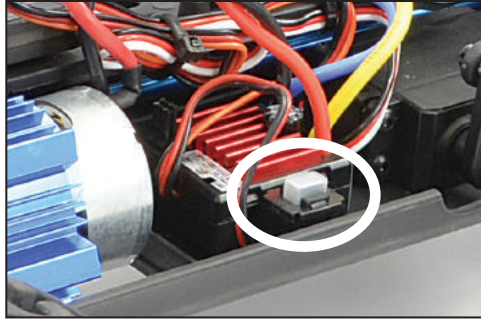

2. TURN ON THE RADIO CONTROLLER

Switch on the power switch on the radio controller. Your radio is bound with your car automatically.



3. CHECK STEERING PERFORMANCE

CENTRE

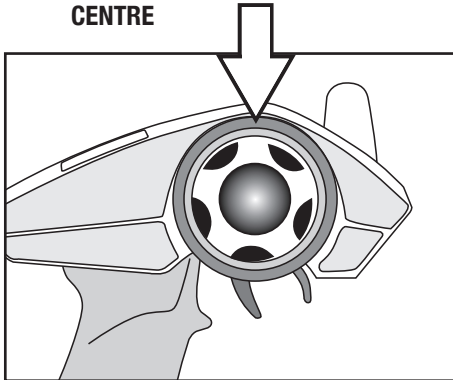

1. To keep the car running straight, keep the steering wheel centered.

TURN RIGHT

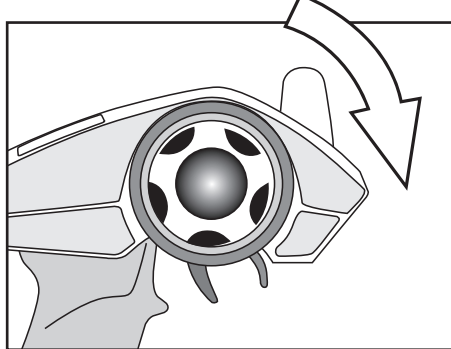

2. Turn the steering wheel to the right to allow the car to right.

TURN LEFT

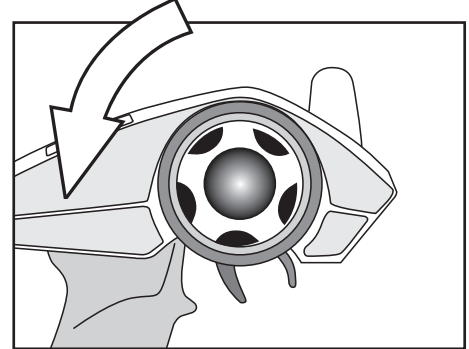

3. Turn the steering wheel to the left to allow the car to turn to the left.

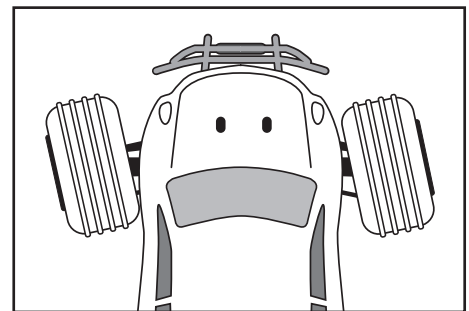
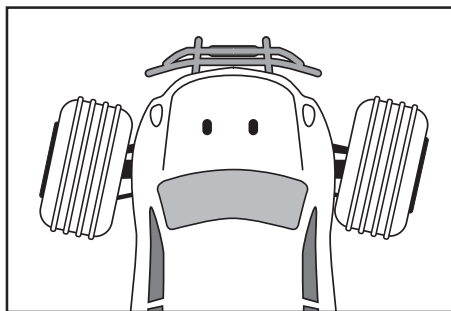
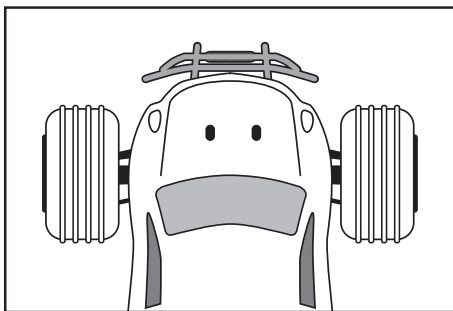

4. CHECK TRIGGER RESPONSE

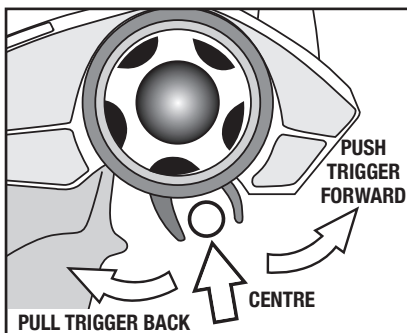

PLEASE NOTE: THE MODEL SWITCHES BETWEEN FORWARD AND REVERSE INSTANTLY FOR SLOW SPEED MANOEUVABILITY. EXCESSIVE USE OF THIS FEATURE CAN CAUSE TRANSMISSION AND ESC DAMAGE.

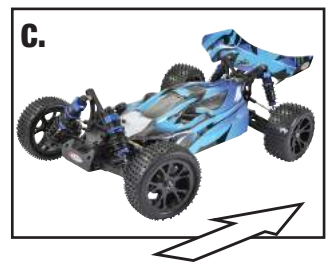

A. Pull the trigger back to accelerate, release it to decelerate.
B. To stop running your car, release the trigger to neutral.
C. Pushing the trigger forward activates reverse.



RUNNING YOUR CAR

5. TUNING THE STEERING TRIM

STEERING TRIM BUTTONS

Gently pull the trigger to allow your car to run slowly. Meantime, tune the steering trim to allow the front wheels to be aligned by pressing the left or right buttons. The neutral position of the trim adjustment is identified by a long beep.



STEERING

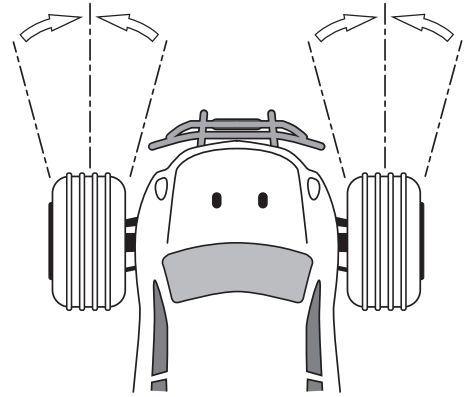

6. TUNING THE THROTTLE TRIM

THROTTLE TRIM BUTTONS

Throttle Trim is used to set the idle speed of the car, by pressing the left or right buttons. The neutral position of the trim adjustment is identified by a long beep.



THROTTLE TRIM

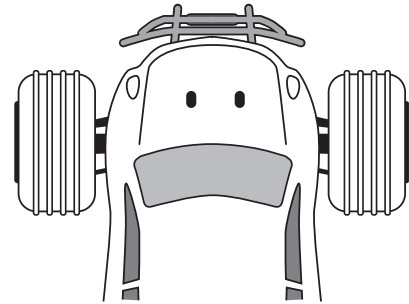

7. TO TUNE THE STEERING DUAL RATE CONTROL DIAL

STEERING D/R KNOB

The dial marked 'ST./RD' on the transmitter controls the amount of servo travel. You should adjust this to give maximum steering without straining the servo. Turning the dial clockwise gives more travel and turning it anti-clockwise gives less travel.

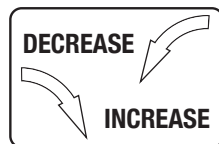

STEERING D/R

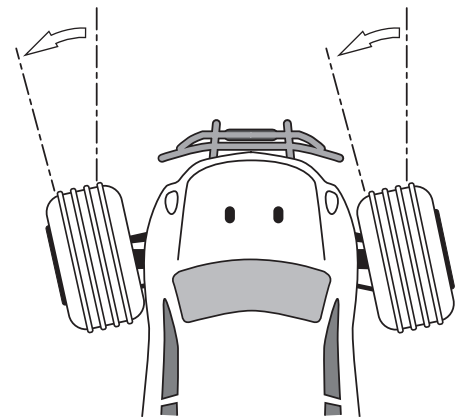

Set the Steering Dual Rate Control Dial to minimum first. To set the desired steering wheel level increase it again whilst decelerating your vehicle.

8. STEERING/THROTTLE REVERSE

STEERING REVERSE:

To reverse the direction of servo travel, please press and hold the 'ST R/N' button for steering (CH1) or "TH R/N" for throttle (CH2) for a few seconds until you hear a beeping sound, then release the button.

THROTTLE REVERSE:

Allows you to electronically switch the direction that the motor operates in relation to the throttle trigger. For example, if you pull the throttle trigger to accelerate forward but the model goes in reverse, flip the Throttle Reverse switch to make the model accelerate forward.





Getting Started

Switch on transmitter. Hold vehicle clear of the ground, connect battery pack and switch on receiver. Bind the Transmitter and receiver if required.

Test the transmitter to check control of the vehicle with wheels off the ground. Start driving slowly and if the vehicle does not go straight, adjust steering trim dial on Transmitter. For the very first run use the throttle gently, to gradually bed in the motor brushes and help the driver become accustomed to the vehicles behaviour and controls.

PLEASE NOTE:

Although the electronics are waterproof the rest of car can be subjected to damage if running in excessively wet or submerged conditions.

After Run.

Switch off the receiver power, switch off the transmitter and lower the aerial. Disconnect the battery and remove it from the vehicle, allow it to cool before recharging. If you have a second charged battery all ready to use, still allow the vehicle to cool slightly before continuing.

Regular maintenance.

Frequently check the whole vehicle for loose or missing fixings. Use thread lock on any replacement screws into metal threads.

Frequently check rotating parts are free from grass, string etc. that might bind their motion and over stress the motor or speed controller. Remove the wheels occasionally and check behind the mounting hex for obstructions or anything that might have been wrapped around the axle and caused extra drag.

Check the gear mesh frequently and remove any stones or grit from gear teeth to prevent premature wear and damage.

If the motor moves, or is removed for maintenance/exchange, the gear mesh will need to be set. Simply slacken the motor retaining screws and adjust the motor until there is just discernable backlash between pinion and spur teeth. If the gear is too tight or too loose the gears will be noisy and could be damaged.

Shock absorbers will wear prematurely if used in dirty dusty conditions. Replace oil and seals as required to keep a smooth dampening action.

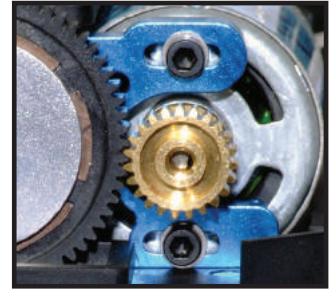

Trouble shooting guide.

Short Runtime: Battery damaged/not charged Motor dirty or brushes worn Drivetrain binding	Sluggish Action: Motor dirty or brushes worn Bind in drive train Battery running low on power	Motor/ESC overheat: Over-gearred Binding transmission. Seized axle bearing. Motor binding	Motor spins but vehicle refuses to move: Gears damaged. Gears loose on shaft. Slipper clutch too loose. Drive shaft broken or missing.	Poor Range or fails to operate: Transmitter batteries low Vehicle Battery Low. Transmitter switched off Transmitter/receiver aerial not extended. ESC switched off or battery not connected. Loose connectors/wires. Water damage. Model electronics are not waterproof.
---	---	--	---	--

Warranty

Due to the nature of this product and potential use FTX warrants it to be free of material and workmanship defects when new. FTX will at its sole discretion repair or replace defective components free of charge within 30 days from date of purchase. This warranty does not cover wear and tear, crash or impact damage, modifications, component water damage failure to perform maintenance or damage from improper use. Proof of purchase date will be required to action any warranty claims. In no case shall FTX's liability exceed the original cost of the purchased kit.

Instructions for disposal.

Environmental Protection Notes & WEEE

The crossed-out wheeled bin symbol shown here, which may be found on the product itself, in the operating instructions or on the packaging, is in accordance with the Waste Electrical and Electronic Equipment (WEEE) Directive. Individual markings indicate which materials can be recycled and re-used. You can make an important contribution to the protection of our common environment by re-using the product, recycling the basic materials or recycling redundant equipment in other ways.

When this product comes to the end of its useful life, you must not dispose of it in the ordinary domestic waste. Many electrical items that we throw away can be repaired or recycled. Recycling items helps to save natural resources and also reduces the environmental and health impacts that are linked with sending electrical goods to landfill. The correct method of disposal is to take it to your local collection point for recycling electrical and electronic equipment. You can go to recycle-more.co.uk for details of locations.

Alternatively FTX can offer our customers free take-back of their WEEE on a like-for-like basis when they buy a new Electrical or Electronic product from us. For example, if a customer bought a new radio system from us or a dealer, we would accept their old radio and prevent it going into a landfill site by disposing of it safely. Customers must return their old WEEE item to us within 28 days of purchasing their new item.

Remove batteries from your device and dispose of them at your local collection point for batteries. If you don't know the location of your nearest disposal centre, please enquire at your local council office.



CML Distribution, Saxon House, Saxon Business Park, Hanbury Road,
Bromsgrove, B60 4AD. WEE/GB4215VX



Le FTX Vantage 2.0, une voiture de trail à l'échelle 1/10 prête à rouler

Merci d'avoir choisi le FTX 'Vantage 2.0'
Ce modèle est monté d'usine, l'électronique est pré installée et réglée pour permettre un démarrage et du plaisir le plus rapidement possible.

This 1/10th scale model has been factory assembled and all electrics installed and set up to make it the easiest possible introduction to the sport of driving RC cars.

Attention: lisez l'intégralité du manuel pour exploiter au mieux la voiture et éviter des dommages mécaniques ou corporels. Ce modèle n'est pas un jouet, il doit être manipulé avec précaution. Utilisé dans de mauvaises conditions, ce modèle peut causer des dommages.

Ce modèle n'est pas fait pour être utilisé par un enfant sans la surveillance directe d'un adulte.

Il est essentiel de lire et de suivre les instructions et les recommandations de ce manuel pour entretenir et faire évoluer votre modèle dans de bonnes conditions.



Mesures de sécurité:

- Vous êtes responsable lors de l'évolution de ce modèle, veillez à ne pas vous mettre en danger, à mettre en danger le modèle ou la propriété d'autrui.
- Ce modèle radiocommandé peut être perturbé par d'autres sources d'onde radio, ce qui peut entraîner la perte momentanée du contrôle de la voiture.
- Age recommandé : 14 ans, ceci n'est pas un jouet, ce produit n'est pas fait pour être utilisé par un enfant sans surveillance.

Suivez consciencieusement les instructions suivantes :

- Ne jamais évoluer avec des batteries d'émission faibles
- Toujours évoluer dans une zone dégagée, loin de la circulation et de la foule
- Ne jamais évoluer dans une rue ou un endroit fréquenté
- Toujours garder le modèle dans son champ de vision
- Gardez hors de portée des enfants tous les composants de petite taille, électriques ou chimiques
- Tenez le modèle hors de portée de l'eau (la rouille peut causer des dommages irréversibles au modèle)
- Faites attention aux pièces en rotations, axes, pignons etc.
- Les débutants doivent prendre conseil auprès de personnes plus expérimentées
- Faites attention lors de l'utilisation des outils
- Attention à ne pas mettre les doigts ou d'autres parties du corps en contact avec les pièces en rotation
- Faites attention lors du transport, de la maintenance ou de la réparation, certaines pièces peuvent être coupantes.
- NE JAMAIS toucher les composants tels que le moteur, le variateur ou les batteries après utilisation, ces pièces peuvent être chaudes
- Lorsque vous changez de fréquence d'émission assurez-vous que les quartz de fréquence sont bien positionnés (RX pour récepteur et TX pour l'émetteur)
- Toujours éteindre en premier la voiture avant l'émetteur
- Vérifiez le bon fonctionnement de la voiture les roues dans le vide (en prenant les précautions nécessaires)
- Prolongez la durée de vie du moteur en le préservant de la surchauffe (la durée de vie du moteur dépend aussi de la fréquence de roulage, des changements rapide de direction avant/arrière, des conditions de roulage difficiles poussière/boue des utilisations abusives tirer/pousser des objets)

Contents:

FTX Vantage 2.0 RTR Buggy
 Transmitter: 2.4ghz Steerwheel
 Charger: USB 500mA Charger
 Battery: 1800mAh 7.2v



EQUIPMENTS REQUIS POUR LA MAINTENANCE:

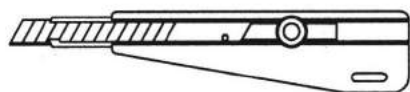

● Cutter



● Règle

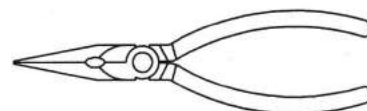

● Pince

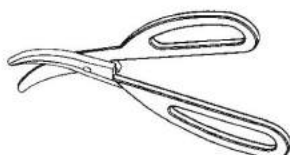

● Ciseaux à lexan

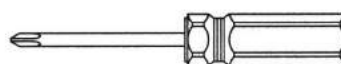
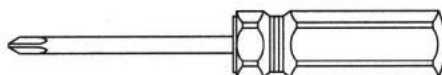

● Tournevis plats et cruciformes

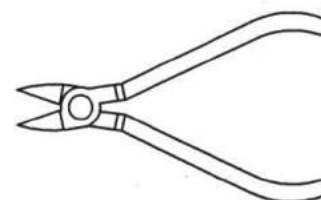

● Pince coupante

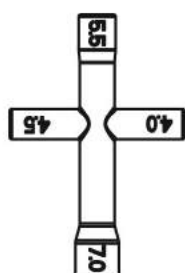

● Clé

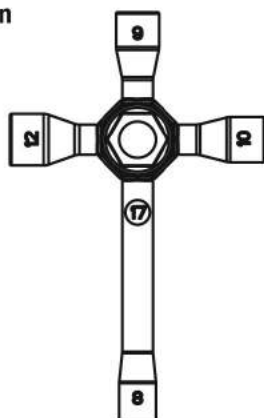

● Colle à pneu



● Frein filet



1. 5mm



2. 0mm



2. 5mm

● Clé Allen

ATTENTION: L'utilisation d'une visseuse électrique pour la maintenance pourrait endommager l'emprunte des vis ou casser des pièces du modèle.

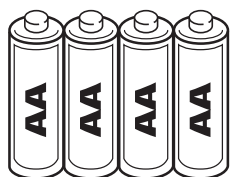

4 piles alcalines AA pour l'émetteur

IMPORTANT: Veuillez vérifier le serrage de chaque vis et écrous avant l'utilisation du modèle.

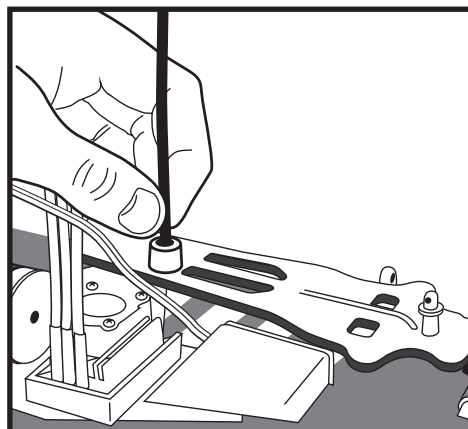
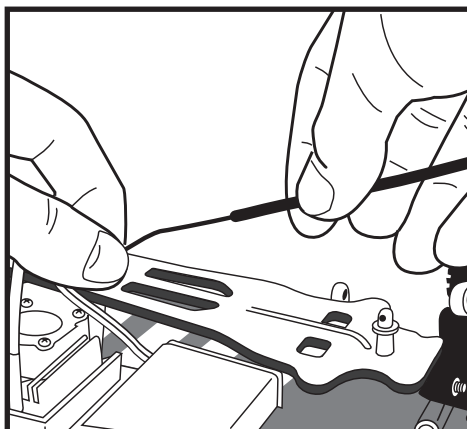
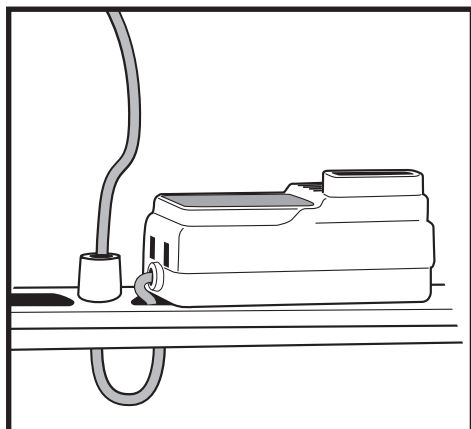

Montage Aérien.

Déroulez soigneusement le fil d'antenne afin de ne pas le plier ou le nouer de toute façon, et assurez-vous d'abord d'insérer le fil par le bas à travers le trou de montage de l'antenne du châssis supérieur. Retirez le capuchon du tube en caoutchouc du tube d'antenne et poussez le fil à travers le tube d'antenne jusqu'à ce que les 5 premiers mm de fil ressortent de l'autre extrémité. Pliez le fil sur l'extrémité du tube et assurez-vous d'insérer le capuchon du tube en caoutchouc de manière à ce qu'il emprisonne le fil en saillie pour le maintenir fermement dans le tube. Poussez le tube d'antenne dans le trou de montage du châssis supérieur jusqu'à ce qu'il soit fermement en place. Regroupez soigneusement tout excédent de fil d'antenne à l'écart des composants rotatifs du châssis.

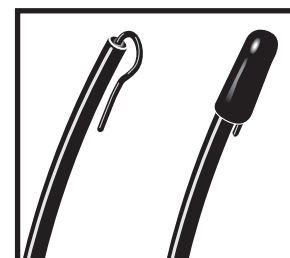

CHARGEMENT ET MONTAGE DE LA BATTERIE.

Stockez toujours votre voiture avec la batterie débranchée et enlevée

- Chargez toujours votre batterie en dehors de la voiture.
Le chargeur USB inclus met environ 3.5h pour charger la batterie 1800mAh lorsqu'elle est déchargée
- Pendant la charge la LED rouge reste allumée
- Lorsque la batterie est chargée, le LED verte restent allumées.
- La batterie peut légèrement chauffer pendant la charge, mais elle ne doit pas être chaude.
- Si la batterie est chaude, arrêtez immédiatement la charge. Débranchez alors la batterie du chargeur dès que la LED du chargeur devient verte.

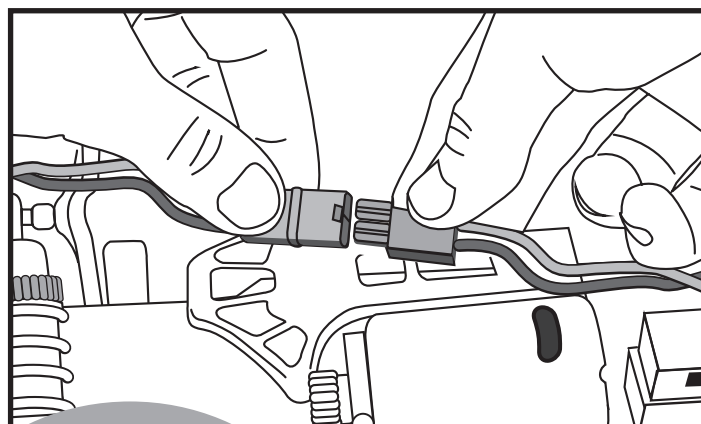

Pour monter une batterie chargée, vous devez d'abord enlever la carrosserie puis insérez la batterie dans son emplacement en la serrant bien correctement grâce aux scratchs en velcro. Lorsque vous branchez la batterie et mettez la batterie et mettez l'interrupteur sur ON, faites bien attention à ce que les roues ne touchent pas le sol ou tout autre chose.

NOTES SUR L'UTILISATION DE LA BATTERIE:

Laissez toujours la batterie refroidir après son utilisation avant de la recharger.

- Inspectez toujours la batterie avant de la charger
- Tout fil dénudé, connecteur coupé ou fuite montre une mauvaise utilisation de la batterie
- N'essayez jamais de charger une batterie endommagée ou morte
- Ne démontez pas la batterie et/ou ne coupez pas les câbles
- Si la connectique de la batterie devient tellement chaude qu'elle fond, cela indique qu'il y a un problème important avec votre voiture, la transmission, les câbles de la batterie ou le contrôleur de vitesse. Trouvez alors l'origine du problème et corrigez-le avant de monter une autre batterie
- Ne chargez jamais la batterie sans la surveiller en cas de surcharge, vous devez pouvoir monitorer la charge à tout moment
- Chargez la batterie éloignée de tout matériaux inflammables sur une surface non inflammable dans le cas où la batterie deviendrait trop chaude.

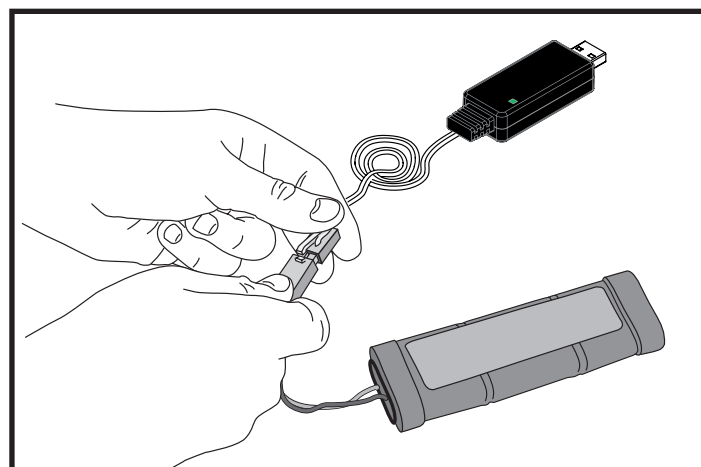

FAMILIARISEZ VOUS AVEC VOTRE SYSTÈME RADIO 2.4 GHZ

ETRONIX

PULSE

EX3G 2.4GHz FHSS RADIO SYSTEM

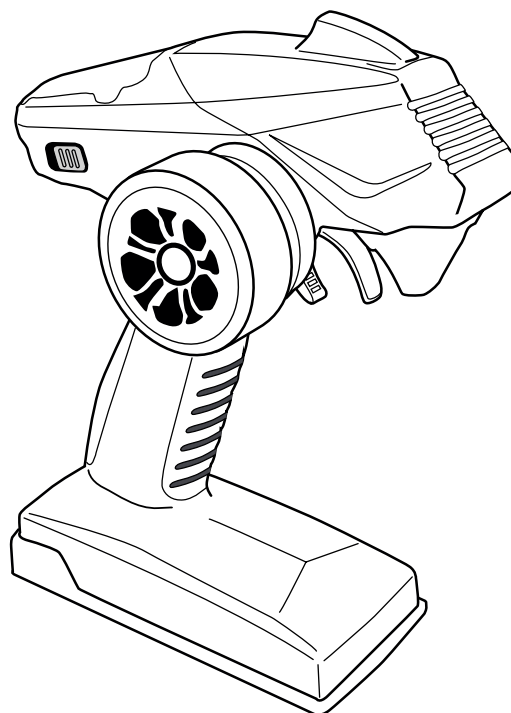

MESURES DE SÉCURITÉ :

Ce système radio a spécialement été développé pour les modèles RC de compétition. Pour votre sécurité, veuillez suivre avec attention les conseils qui suivent.

1. Suivez toujours les lois et réglementations locales qui sont appliquées aux modèles radios commandés.
2. Allumez toujours la télécommande avant d'allumer le récepteur. Lorsque vous souhaitez éteindre le système, éteignez d'abord le récepteur, puis la télécommande.
3. N'essayez pas de bidouiller ou modifier le système. Nous ne serions alors en aucun cas responsable des dégâts que vous causeriez.
4. Assurez vous que les batteries de la télécommande et du récepteur soient toujours chargées et qu'il reste largement assez d'énergie pour ce que vous souhaitez faire. De plus vérifiez que les servos soient bien connectés au récepteur.
5. Gardez toujours la télécommande éloignée de l'humidité, de la chaleur, du feu et des interférences électroniques.
6. Branchez le servo de direction sur la voie 1 et le servo des gaz sur la voie 2 du récepteur. La 3eme voie est une voie auxiliaire.
7. Assurez de ne régler le système radio seulement et uniquement lorsque votre modèle est à l'arrêt. N'essayez pas de le régler lorsque votre véhicule est en mouvement.
8. L'avertissement intégré de tension faible s'active dès que la tension de la batterie descend en dessous de 4,4 V. La LED va alors clignoter en bleue et sera accompagnée d'un beep.
9. L'ajustement du débattement des servos (EPA) a un impact sur la durée de vie de vos servos. Vous devez le régler afin que le servo ne force pas lorsque vous rentrez en butée mécanique. Sinon il va s'user plus rapidement et est plus à même de casser.
10. Etronix n'est en aucun responsable de tout dommage conséquent et entraîné par la manipulation de ce système radio.

GUIDE D'UTILISATION RAPIDE

Relier le récepteur à la télécommande (Bind) :

1ère étape : Allumez la télécommande tout gardant le récepteur éteint. Restez appuyé sur le bouton de la 3eme voie situé au niveau de la poignée de la télécommande jusqu'à ce que vous entendiez un beep et que la LED de la télécommande clignote en bleu. La télécommande est alors en mode de liaison.

2eme étape : Allumez le récepteur, la LED sur le récepteur devrait clignoter lentement en vert. Mettez alors la télécommande à côté du récepteur et restez appuyé sur le bouton de liaison (Bind) sur le récepteur jusqu'à ce que vous voyiez la LED clignoter rapidement puis ralentir.

3ème étape : Eteignez la télécommande puis allumez-la. La LED sur le récepteur devrait alors rester allumée en vert. La procédure de liaison est alors terminée.



Réglage du FailSafe :

Le failsafe est une fonctionnalité pensée en cas de coupure de signal entre la radio et le récepteur que ce soit à cause d'une batterie faible, des interférences électroniques, etc. Au lieu que votre véhicule continue sa trajectoire folle, il va, grâce au failsafe (s'il est bien réglé) s'arrêter et éviter tout problème. En effet, dès la coupure, le récepteur va ramener les servos dans une position pré définie que vous devez régler.

Modèle électrique : Le failsafe est déjà configuré en sortie de boîte.

Modèle thermique : Poussez la gâchette des gaz comme si vous freinez à fond, et restez appuyé sur le bouton F/S du récepteur jusqu'à ce que la LED clignote en vert. Lorsque la LED reste allumée en vert, cela signifie que le failsafe est réglé.

Note : Chaque fois que vous effectuez une procédure de liaison sur un récepteur, vous devez ensuite rerégler le failsafe.

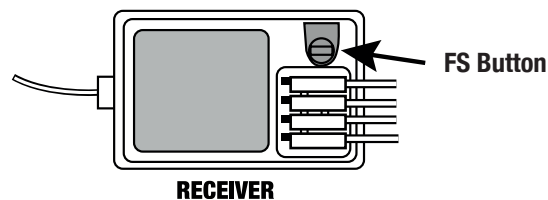

Connection :

Du récepteur

1. Le servos de direction doit être connecté sur le Channel 1 du récepteur tandis que le servos de gaz/frein ou le variateur doit être connecté sur le Channel 2.

2. Le Channel 3 fonctionne comme un interrupteur double position. Il peut servir à contrôler la marche avant ou arrière (si disponible) sur les modèles thermique ou bien le ratio de transmission (si disponible). Merci de contacter le fabricant de votre modèle pour connaître les détails des options disponibles.

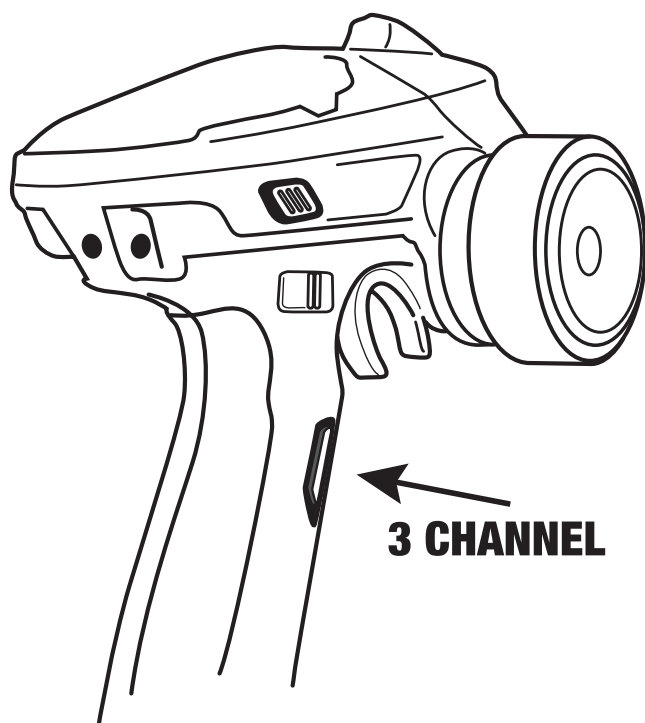
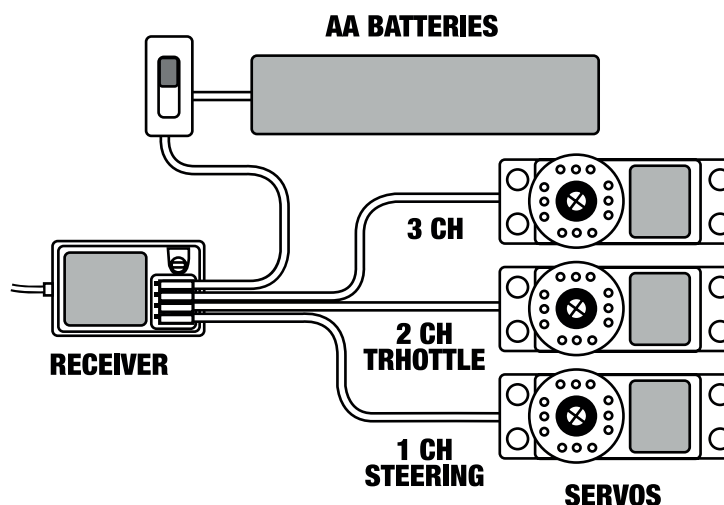

3ème voie (3CH) :

Appuyez une fois sur le bouton de la 3ème voie sur la télécommande afin d'activer la voie, et réappuyez dessus pour que le servo revienne dans sa position au neutre.



Première utilisation du contrôleur de vitesse

1 Schéma de montage

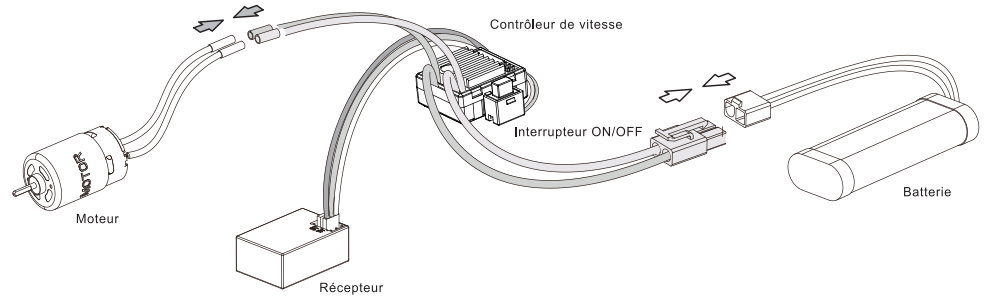

ATTENTION

1. Ce contrôleur de vitesse n'est pas protégé contre les inversions de polarités. Vous devez donc faire attention lorsque vous branchez la batterie. Vérifiez bien que les polarités soient correctes, dans le cas contraire, nous ne serons pas responsables des dégâts occasionnés.

2. Dans le cas où le moteur tournerait dans le mauvais sens, il vous suffit d'inverser les deux fils du moteur.

Caractéristiques du produit

Modèle	TB-60025	TB-60060
Marche avant : Continue / Pic	25A/100A	60A/360A
Marche arrière : Continue / Pic	25A/100A	30A/180A
Type de batterie	1-2s Li-Po, 4-6cells Ni-mh	2-3s Li-Po, 5-9cells Ni-mh
Type de modèle	1/18, 1/24 - piste, tout-terrain, monster truck et truggy	1/10, 1/12, 1/16 - piste, tout-terrain, short course, buggy, crawler et tank
Tour du Moteur (T)	LiPo 1S (Si 1 élément est utilisé seulement les batteries LiPo sont supportées)	Moteurs 030, 050, 280 avec moins de 3000 t/min à 7,2V
	LiPo 2S ou NiMh 6 éléments	Moteurs 280, 370, 380 avec moins de 3000 t/min à 7,2V
Résistance interne	CW : 0.003 Ω, CCW : 0.003 Ω	CW : 0.001 Ω, CCW : 0.002 Ω
Tension de sortie du BEC	1A pour 6V (Régulateur linéaire)	3A pour 6V (Régulation alternée)
Taille / Poids	32,2x25,3x16,9mm/23,5g	34,5x30,2x18,7mm/39g
Mode	Bateaux, Marche avant / arrière, Crawler	Bateaux, Marche avant / arrière, Crawler

2 Réglage des gaz

Allumez la télécommande, et réglez dessus le Dual Rate et les débattements 100%. Le trim des gaz doit être en position neutre. Nous vous recommandons fortement d'utiliser la fonction failsafe et de la régler sur le neutre.

Allumez le contrôleur de vitesse et laissez la gâchette des gaz en position neutre. Le contrôleur de vitesse va automatiquement détecter et calibrer le neutre dans les 3s. Une fois le réglage effectué, un beep va être émis.

Correspondance du type de batterie en fonction des beep émis	Indications de la LED lors du fonctionnement
<ul style="list-style-type: none"> Un batterie NiMh Deux beep court: Lipos 2S Trois beep court: Lipo 3S Un beep long: Fonctionnement normal 	<ul style="list-style-type: none"> LED éteinte : Gâchette des gaz en position neutre LED clignota des gaz ni en position haute ni en position basse LED allumée: Gâchette des gaz en te ou basse (à fond)

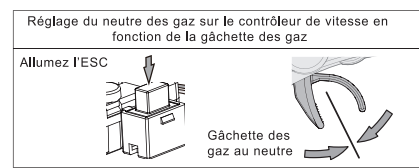

Modes et réglage du type de batterie

Mode de réglage :

1. Le mode et le type de batterie sont réglables grâce au connecteur pont.

Utilisez le pont pour sélectionner le mode et le type de batterie en vous appuyant sur le schéma ci-dessous.

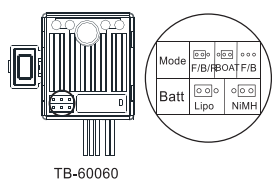

Réglage :

1. Mode : Marche avant / Frein / Marche arrière (F/B/R) (par défaut), Bateau (boat), Crawler (F/B).

Explication du mode Marche avant / Frein / Marche arrière : votre modèle peut avancer, freiner et reculer. Afin d'éviter toute marche arrière brusque, pour reculer, vous devez d'abord freiner en poussant la gâchette des gaz, puis repousser de nouveau la gâchette des gaz afin de reculer.

Le mode bateau ne peut pas freiner, vous pouvez seulement accélérer ou reculer. Le mode crawler peut seulement avancer et reculer, mais il possède du frein moteur.

2. Par défaut le mode de la batterie est sur LiPo

Fonctionnalités de sécurité

- Protection de la batterie :** Lorsque votre contrôleur de vitesse détecte que le niveau de votre batterie est inférieur à une valeur déterminée, il entre dans le mode de protection. (Normalement il y a 2 étapes : D'abord la puissance est diminuée, puis l'alimentation est coupée)
- Protection de température :** Lorsque la température interne du contrôleur de vitesse dépasse les 100°C, la puissance délivrée au moteur est diminuée afin d'éviter que la voiture ne stop brutalement. La LED clignote alors. Le contrôleur de vitesse retourne en mode normal lorsque la température redescend en dessous de 80°C lorsque le mode bateau est sélectionné. La puissance est divisée par deux lorsque la tension est faible. La LED clignote alors rapidement. Vous devez alors faire revenir votre véhicule vers vous surtout si c'est un bateau.

LiPo 1S	LiPo 2S	LiPo 3S	NiMh 5-9 éléments
La tension descend à 3,2 V. La LED clignote alors rapidement et l'alimentation est coupée	La tension descend à 6,5 V. La LED clignote alors rapidement et la puissance est divisée par 2. Lorsque la tension descend à 6V, la LED clignote lentement et l'alimentation est coupée	La tension descend à 9,5 V. La LED clignote alors rapidement et la puissance est divisée par 2. Lorsque la tension descend à 9V, la LED clignote lentement et l'alimentation est coupée	La tension descend à 4,5 V. La puissance est divisée par 2. Lorsque la tension descend à 6V, l'alimentation est coupée



GESTION DE VOTRE VOITURE

1. METTRE SUR ON INTERRUPTEUR

L'ensemble variateur/ récepteur se situe sur ON comme montré sur la photo.

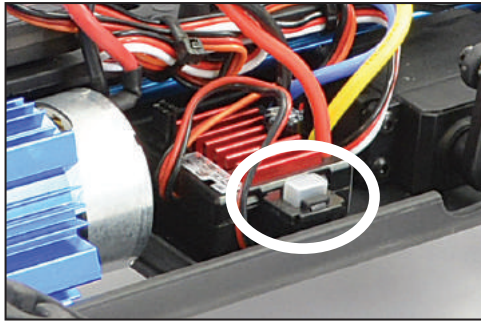

2. METTRE LA RADIO SUR ON

Mette le bouton d'allumage de la radio sur ON. Votre voiture est automatiquement appairer avec votre radio.



3. ASSURE UNE BONNEPERFORMANCE DE PILOTAGE

CENTRE

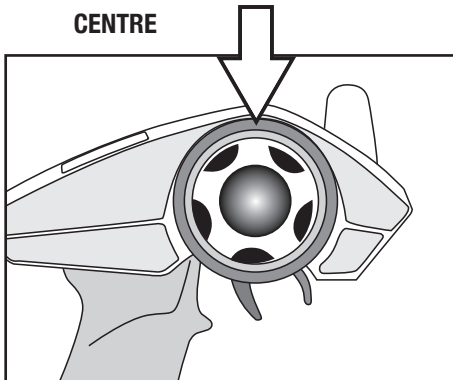

1. Pour que la voiture aille droite ne pas tourner le volant (le laisser au centre).

TOURNE À DROITE

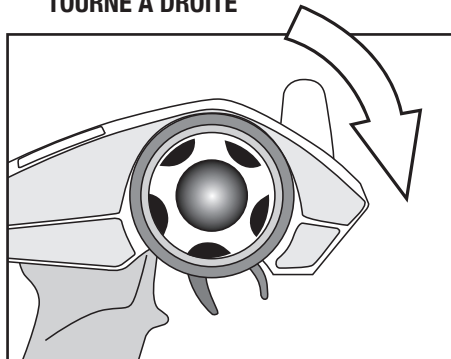

2. Tourner à droite pour permettre à votre d'aller à gauche.

TOURNE À GAUCHE

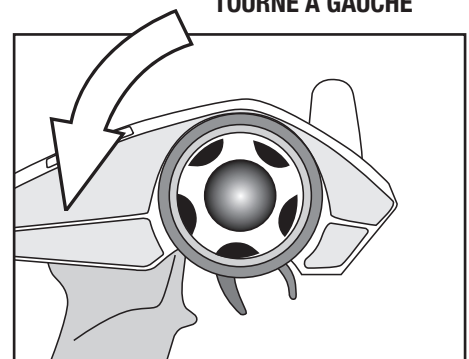

3. Tourner à gauche pour permettre à votre voiture d'aller à droite.

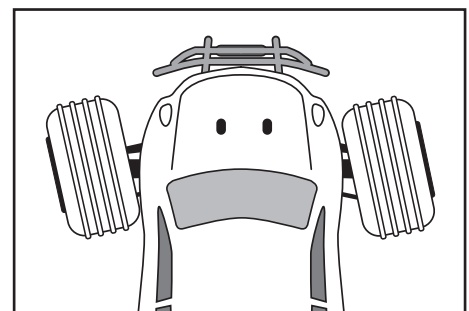
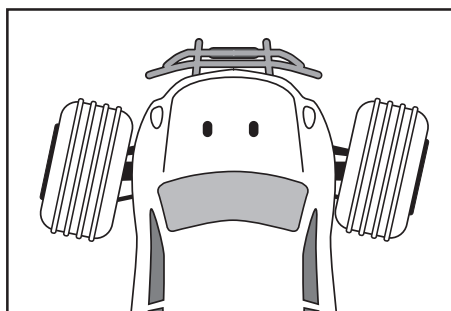
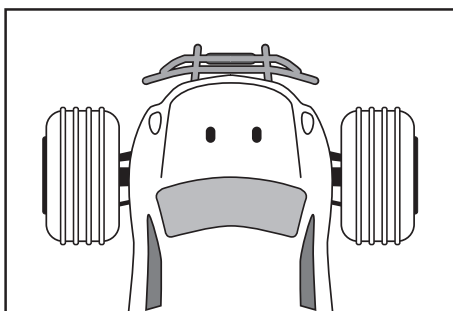

4. VÉRIFIER LA REEONSE DE LA GACHETTE

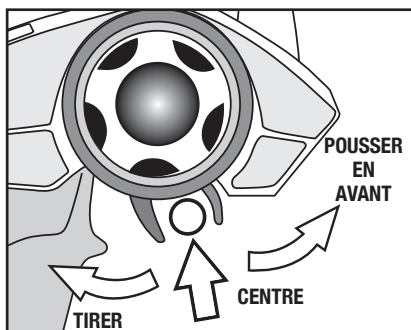

S'IL VOUS PLAÎT NOTEZ :
LE MODÈLE PASSE ENTRE LA MARCHÉ AVANT ET ARRIÈRE INSTANTANÉMENT POUR UNE MANŒUVRABILITÉ À FAIBLE VITESSE. UNE UTILISATION EXCESSIVE DE CETTE FONCTIONNALITÉ PEUT ET VA ENDOMMAGER LA TRANSMISSION ET L'ESC.



A. Tirer la gâchette en arrière pour accélérer? La lâcher pour décélérer et la pousser pour freiner.

B. Pour arrêter la voiture, lâchette jusqu'au neutre.
C. Pousser la gâchette vers l'avant active la marche arrière.

GESTION DE VOTRE VOITURE

5. POUR MODIFIER LE TRIM DE DIRECTION

Placer la voiture sur le stand avec les roues qui ne touchent pas le sol, puis régler le Trim de direction pour aligner les roues avant.



TRIM DE DIRECTION

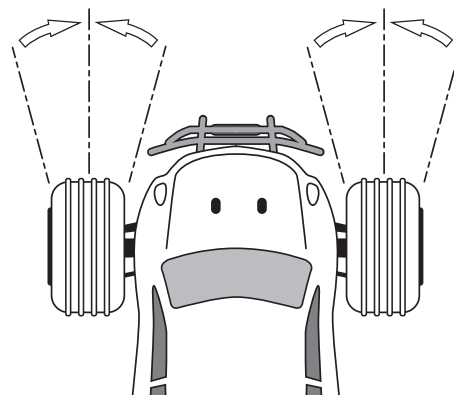

6. POUR MODIFIER LE TRIM DE GAZ

Trim des gaz est utilisé pour régler la vitesse de ralenti



TRIM DE GAZ

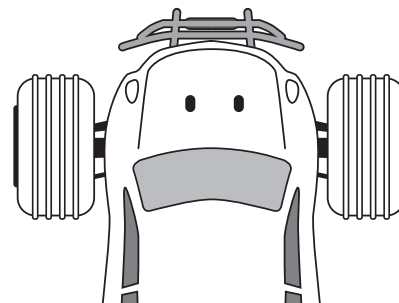

7. POUR MODIFIER LA COURSE (DIR) DE LA DIRECTION

Ce réglage ajuste la course du servo de direction. Pousser le bouton en avant pour un maximum de directivité. Tirer en arrière pour réduire la course du servo.

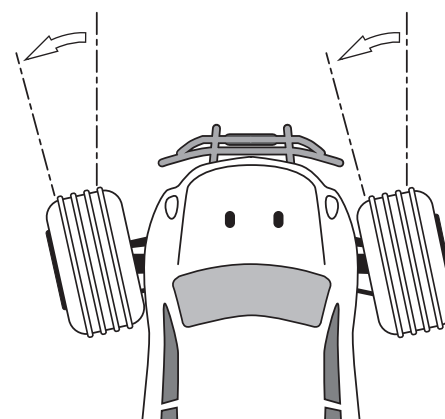
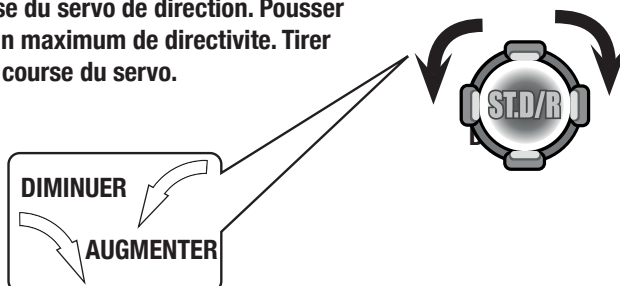

Note: Toujours minimiser et augmenter ensuite pendant que votre voiture.

8. REG/AGE DES REVERSES DIRECTION/GAZ

DIRECTION REVERSE:

Cela permet électroniquement d'inverser le sens de rotation du servo. Par exemple si vous si vous tournez le volant à droite.



GAZ REVERSE:

Cela vous permet de changer électroniquement la direction dans laquelle le moteur opère en relation avec la gâchette des Gaz. Par exemple, si vous poussez la gâchette pour accélérer en avant, mais le modèle va en arrière, inverser le Gaz Reverse permettra au modèle d'accélérer en avant.





En route

Dépliez l'antenne passez sur ON la radio, tenez la voiture les roues en l'air, connectez les batteries puis allumez la voiture. Testez la voiture les roues en l'air pour vous assurer de son bon fonctionnement puis poser la voiture au sol et testez doucement son fonctionnement. Si la voiture ne va pas droit ajustez le trim de direction. Lors de la première utilisation accélérez doucement pour vous familiariser avec l'utilisation de la voiture.

S'IL VOUS PLAÎT NOTE

IMPORTANT : Veuillez noter que ce véhicule n'est pas étanche et ne doit pas être exécuté dans des conditions mouillées ou humides où l'humidité pourrait pénétrer dans l'électronique.

Arrêt du modèle

Eteignez l'interrupteur du récepteur (voiture), éteignez ensuite l'interrupteur de la radio-commande puis repliez l'antenne. Débranchez ensuite les batteries et retirez celles-ci de la voiture.

Laissez les batteries refroidir avant des les recharger. Si vous possédez une seconde batterie déjà chargée, laissez le véhicule refroidir quelques minutes avant d'installer cette deuxième batterie.

Entretien.

Vérifiez souvent que des vis ne sont pas absentes ou dévissées. Utilisez du frein filet pour tout remplacement de vis dans du métal. Vérifiez que les pièces en rotation sont bien libres (herbe, pierre etc.). Si ces pièces ne sont pas libres cela peut les endommager ou encore user le moteur ou le variateur. Enlevez les roues et vérifiez que rien ne s'est glissé derrière l'hexagone de roue et n'empêche une bonne liberté de la transmission. Si le moteur bouge ou est enlevé pour entretien/échange, vous devez refaire le réglage de l'entre dents. Pour cela devisez les vis moteur et bougez-le jusqu'à avoir un petit jeu fonctionnel entre le pignon moteur et la couronne. Si ce réglage est mal fait la transmission peut être bruyante mais aussi s'endommager. Les amortisseurs vont s'user plus vite si vous roulez dans des conditions poussiéreuses, remplacez l'huile ainsi que les joints pour conservé un bon amortissement.

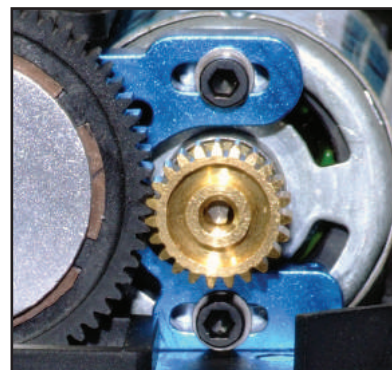

Solutions aux problèmes:

Durée de roulage très courte:	Vitesse lente:	Le moteur ou le variateur surchauffe:	Le moteur tourne mais la voiture n'avance pas:	Une portée courte ou aucun contrôle de la voiture:
Les batteries sont endommagées ou mal chargées.	Le moteur est sale ou les charbons usés.	La transmission n'est pas libre	La transmission est abîmée.	Les piles de la télécommande sont vides, les batteries de la voiture sont vides, l'antenne n'est pas dépliée, un fil est débranché, l'électronique est endommagée.
Le moteur est sale ou les charbons usés.		Le moteur est endommagé.	Le slipper est desserré, un cardant est cassé ou manquant.	

Garantie

De part la nature de ce produit et l'utilisation potentiel, FTX garanti qu'il n'a pas défaut lorsque le modèle est neuf. FTX s'engage à réparer ou remplacer les composants défectueux gratuitement dans un délai de 30 jours à compter de la date d'achat. Cette garantie ne couvre pas l'usure normale, l'accident ou l'impact, les modifications, les dégâts des eaux (appareil n'étant pas étanche) le manque d'entretien ou de dommages causés par une mauvaise utilisation. La preuve de la date d'achat sera nécessaire lors des réclamations de garantie.

Instructions pour la mise au rebut.

Ce produit ne doit pas être jeté avec les autres déchets. L'utilisateur doit le déposer dans un point de collecte et de recyclage des déchets. Pour plus d'informations sur l'endroit où vous pouvez déposer vos déchets, s'il vous plaît contacter votre municipalité, ou bien où vous avez acheté le produit.



CML DISTRIBUTION, SAXON HOUSE, SAXON BUSINESS PARK,
HANBURY ROAD, BROMSGROVE, B60 4AD.

WEE/GB4215VX





EXPLODED PARTS DIAGRAM

FRONT & REAR SHOCK ASSEMBLY

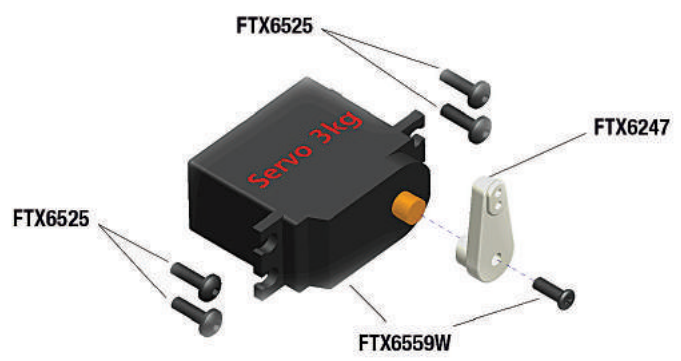
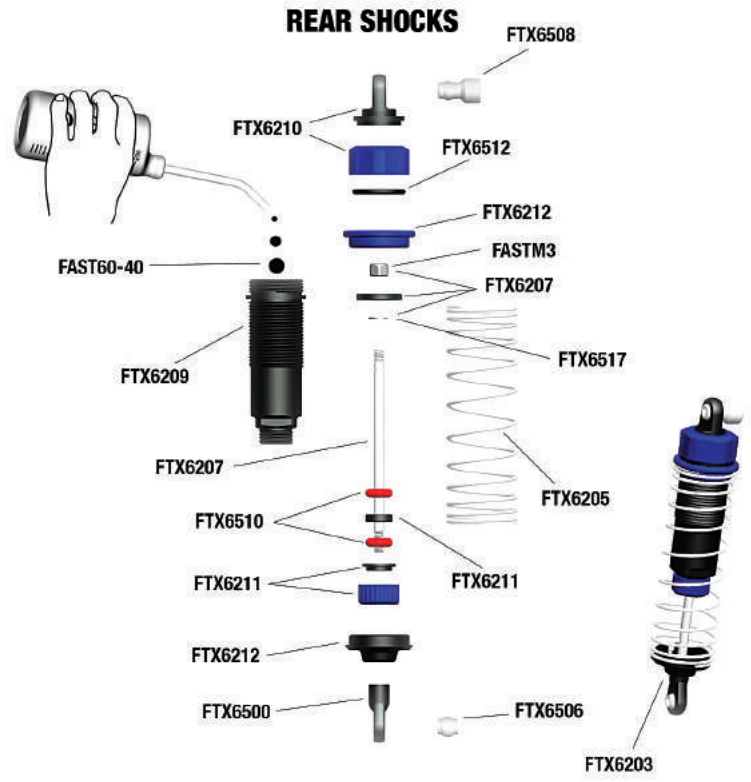
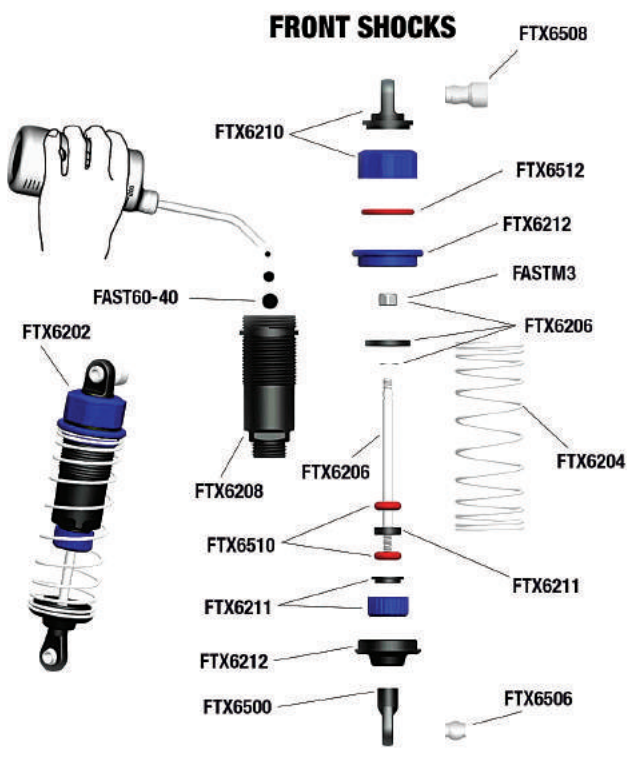

STEERING SERVO



FRONT TYRES

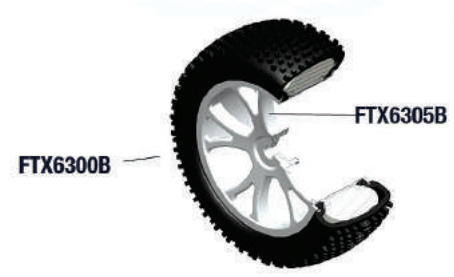

REAR TYRES

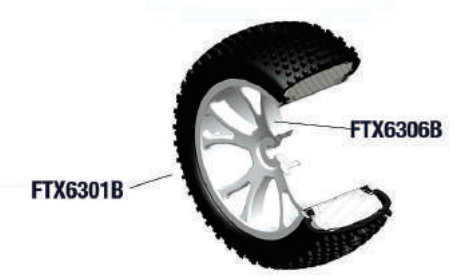



EXPLODED PARTS DIAGRAM

B O M

TYPE	ICON	SPEC	QTY
Round Head Self Tapping Hex Screw		2x10	4
Button Head Hex Screw		M3x12	2
Cap Head Hex Screw		M3x6	4
		M3x18	2
		M3x10	10
Flat Head Hex		M3x12	3
		M3x14	4
		M3x16	2
		M3x36	2
Set Screw		M4x4	1
		M4x10	2
Ring Self Tapping Screw		3x4	2
Washer		#6x0.140.2	2
Nylon Lock Nut		M3	2
E clip		#2.5	5
O Ring		#6.05x4.05x1.55	4
		#6.05x2.5	4
		#15.6x12.6x1.2	2
Ball Bearing		#15x10x4	2
		#10x4x4	6

FRONT ASSEMBLY

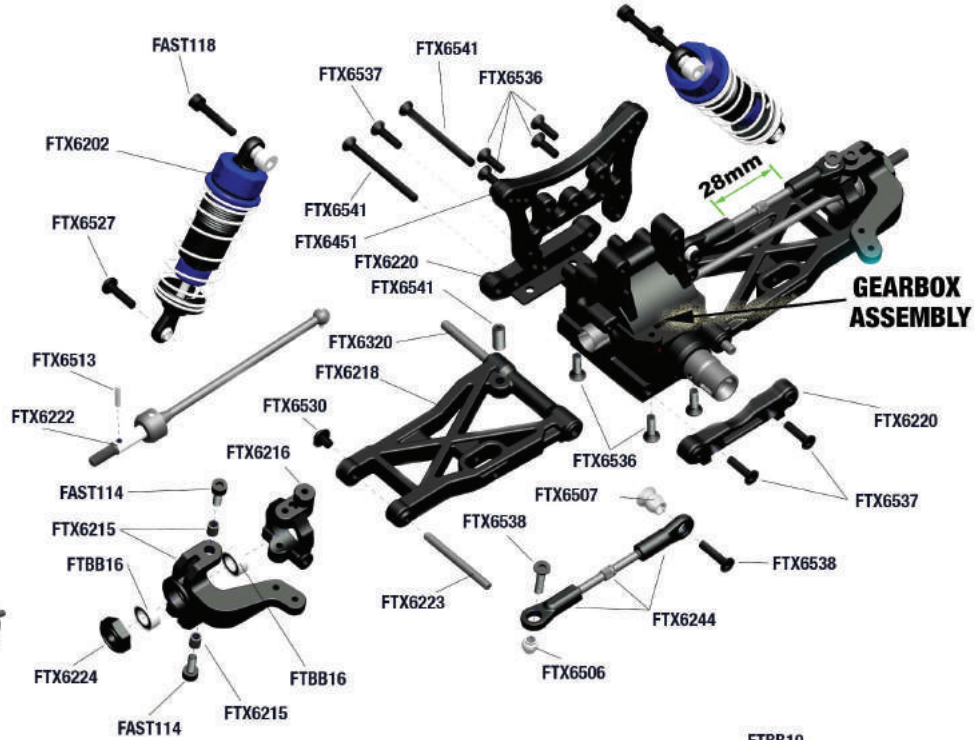

GEARBOX ASSEMBLY

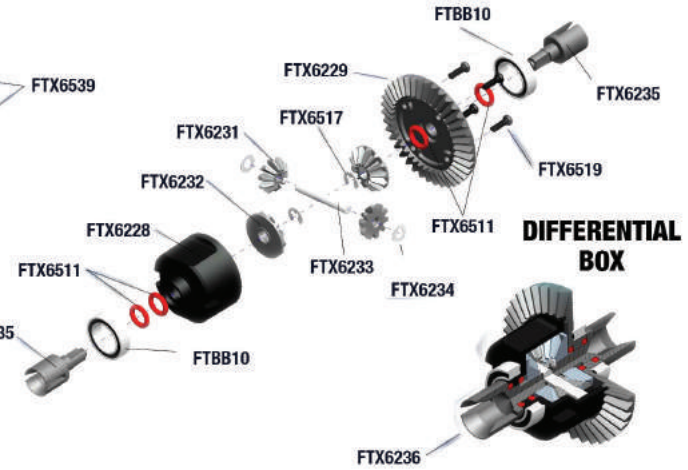
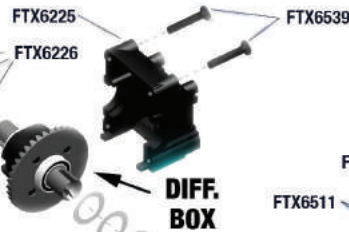
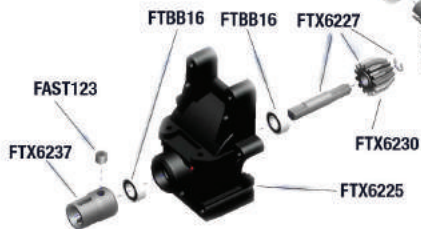

REAR ASSEMBLY

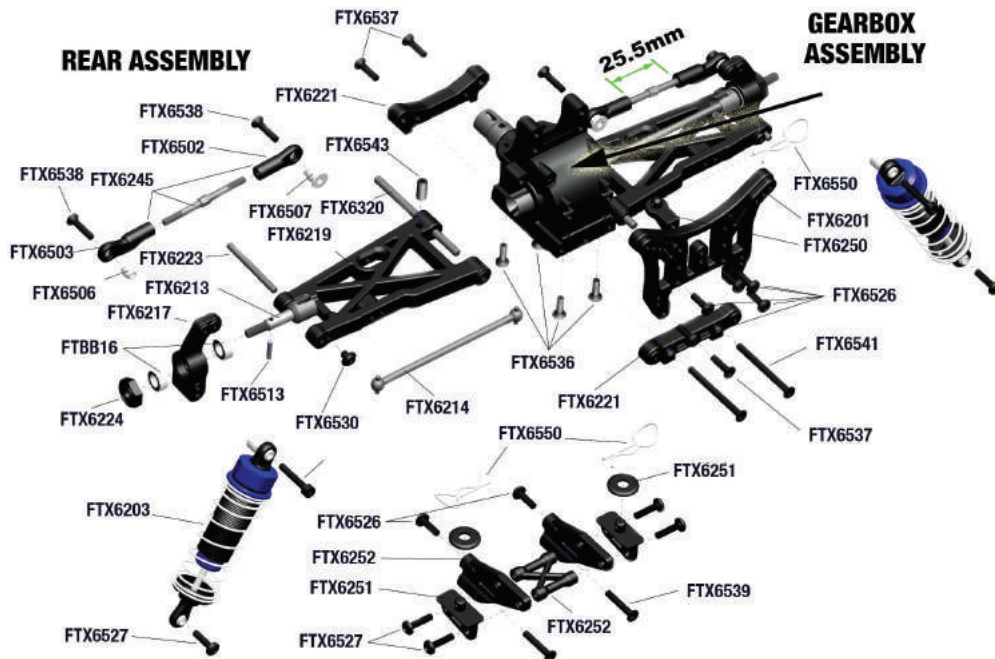

GEARBOX ASSEMBLY



B O M

TYPE	ICON	SPEC	QTY
Round Head Self Tapping Hex Screw		2x10	4
Button Head Hex Screw		M3x8	2
		M3x10	2
		M3x12	6
Cap Head Hex Screw		M3x18	2
		M3x25	1
		M3x10	4
		M3x12	3
Flat Head Hex		M3x14	4
		M3x18	4
		M3x36	2
Set Screw		M4x4	1
		M4x10	2
Ring Self Tapping Screw		3x4	2
Washer		#6x0.140.2	2
Nylon Lock Nut		M3	3
E clip		#2.5	5
O Ring		#6.05x4.05x1.55	4
		#6.05x2.5	4
		#15.6x12.6x1.2	2
Ball Bearing		#15x10x4	2
		#10x4x4	6



EXPLODED PARTS DIAGRAM

<p>FTX6450</p>  <p>Front Shock Tower 1pc</p>	<p>FTX6201</p>  <p>Rear Shock Tower 1pc</p>	<p>FTX6202</p>  <p>Front Shocks 2pcs</p>	<p>FTX6203</p>  <p>Rear Shocks 2pcs</p>
<p>FTX6204</p>  <p>Front Shock Spring 2pcs</p>	<p>FTX6205</p>  <p>Rear Shock Spring 2pcs</p>	<p>FTX6206</p>  <p>Front Shock Shaft & Piston Set 2 sets</p>	<p>FTX6207</p>  <p>Rear Shock Shaft & Piston Set 2 sets</p>
<p>FTX6208</p>  <p>Front Shock Body 2pcs</p>	<p>FTX6209</p>  <p>Rear Shock Body 2pcs</p>	<p>FTX6210</p>  <p>Shock Upper Cap 2 Sets</p>	<p>FTX6211</p>  <p>Shock Lower Cap 2 Sets</p>
<p>FTX6212</p>  <p>Shock Lower Holder & Adjust Ring 2 sets</p>	<p>FTX6215</p>  <p>Steering Knuckle Arms 2 sets</p>	<p>FTX6216</p>  <p>Hub Carrier Uprights 2pcs</p>	<p>FTX6217</p>  <p>Hub Carrier Uprights 2pcs</p>
<p>FTX6213</p>  <p>Rear Drive Axles 2pcs</p>	<p>FTX6220</p>  <p>Front Suspension Holders 2pcs</p>	<p>FTX6221</p>  <p>Rear Suspension Holders 2pcs</p>	<p>FTX6225</p>  <p>Gearbox Housing Set 2pcs</p>



SPARE PARTS LIST

<p>FTX6226</p>  <p>Diff. 16T Gear Washer 6pcs</p>	<p>FTX6227</p>  <p>Diff. Gear w/pin 2 sets</p>	<p>FTX6236</p>  <p>Diff. Gearbox Set 1 set</p>	<p>FTX6228</p>  <p>Diff. Case 2pcs</p>
<p>FTX6229</p>  <p>Diff. Drive Spur Gear</p>	<p>FTX6230</p>  <p>Diff. Drive Gear 2pcs</p>	<p>FTX6231</p>  <p>Diff. Bevel Gear S. 4pcs</p>	<p>FTX6232</p>  <p>Diff. Bevel Gear B. 4pcs</p>
<p>FTX6233</p>  <p>Diff. Pin 2pcs</p>	<p>FTX6234</p>  <p>Washer 6pcs</p>	<p>FTX6235</p>  <p>Diff. Drive Cup</p>	<p>FTX6237</p>  <p>Center Coupler 3pcs</p>
<p>FTX6240</p>  <p>Servo Saver Posts 2pcs</p>	<p>FTX6241</p>  <p>Steering Ackerman</p>	<p>FTX6224</p>  <p>Wheel Hub 4pcs</p>	<p>FAST103</p>  <p>Antenna Pipe Set 2 sets</p>
<p>FTX6300W FTX6300B</p>  <p>Front Buggy Tyre Set (pr)</p>	<p>FTX6301W FTX6301B</p>  <p>Rear Buggy Tyre Set (pr)</p>	<p>FTX6305W OR B (FR)</p>  <p>Front Rim (pr)</p>	<p>FTX6305W OR B (RE)</p>  <p>Rear Rim (pr)</p>







SPARE PARTS LIST

<p>FTX6222</p>  <p>Front CVD 2 Sets</p>	<p>FTX6253</p>  <p>Chassis Front part 1pc</p>	<p>FTX6254</p>  <p>Buggy Front Bumper 1pc</p>	<p>FTX6218</p>  <p>Front Lower Susp. Arms 2pcs</p>
<p>FTX6219</p>  <p>Rear Lower Susp. Arms 2pcs</p>	<p>FTX6252</p>  <p>Wing Bracket 1 set</p>	<p>FTX6251</p>  <p>Wing Holder 1 set</p>	<p>FTX6250</p>  <p>Buggy Body Mount 1 set</p>
<p>FTX6243</p>  <p>Servo Linkage 1pc</p>	<p>FTX6244</p>  <p>Upper Front Susp. Arm 2 sets</p>	<p>FTX6245</p>  <p>Rear Upper Arm 2 sets</p>	<p>FTX6246</p>  <p>Steering Arm 2 sets</p>
<p>FTX6214</p>  <p>Central Dogbone F. 1pc</p>	<p>FTX6255</p>  <p>Battery Cover (EP) 1pc</p>	<p>FTX6256</p>  <p>Battery Posts 2 sets</p>	<p>FTX6257</p>  <p>Rear Spur Gear Cover Post 2pc</p>
<p>FTX6258</p>  <p>Motor Mount (EP) 1pc</p>	<p>FTX6266</p>  <p>Slipper Complete (EP) 1 set</p>	<p>FTX6267</p>  <p>Slipper Pad (EP) 2pcs</p>	<p>FTX6268</p>  <p>Slipper Gasket (EP) 2pcs</p>
<p>FTX6275</p>  <p>Spur Gear (EP) 65T 1pc</p>			



SPARE PARTS LIST

<p>FTX6269P</p>  <p>Slipper Shaft (EP) 1 set</p>	<p>FTX6270</p>  <p>Slipper Spring Bracket (EP) 1pc</p>	<p>FTX6271</p>  <p>Slipper Spring (EP) 1pc</p>	<p>FTX6242</p>  <p>Servo Saver (EP) 1 set</p>
<p>FTX6273</p>  <p>Slipper Drive Cup 1pc</p>	<p>FTX6262</p>  <p>Bearing Bracket (EP) 1pc</p>	<p>FTX6278</p>  <p>Pinion Gear (EP) 23T 1pc</p>	
<p>FTX6259</p>  <p>Chassis Plate (EP) 1pc</p>	<p>FTX6260</p>  <p>Rear Spur Gear Cover (EP) 1pc</p>	<p>FTX6261</p>  <p>Upper Plate (EP) 1pc</p>	<p>FTX6265</p>  <p>Center Drive Shaft (EP) 1pc</p>
<p>FTX6550</p>  <p>Body Clip (med) 6pcs</p>	<p>FTX6551</p>  <p>Body Clip (small) 6pcs</p>	<p>FTX6500</p>  <p>Shock Ball End 6pcs</p>	<p>FTX6501</p>  <p>Servo link Ball End 6pcs</p>
<p>FTX6502</p>  <p>Steering Link Ball End 6pcs</p>	<p>FTX6503</p>  <p>Rear Upper Link Ball End 6pcs</p>	<p>FTX6504</p>  <p>Sway Bar Fix Plate 6pcs</p>	<p>FTX6505</p>  <p>Sway Bar Holders 6pcs</p>



















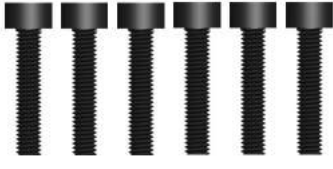

SPARE PARTS LIST

<p>FTX6506</p>  <p>Ball A 6pcs</p>	<p>FTX6507</p>  <p>Ball B 6pcs</p>	<p>FTX6508</p>  <p>Ball C 6pcs</p>	<p>FTX6509</p>  <p>Ball D 6pcs</p>
<p>FTX6510</p>  <p>Shock O-Ring Lower 6pcs</p>	<p>FTX6511</p>  <p>Diff. O-Ring Seal 6pcs</p>	<p>FTX6512</p>  <p>Shock O-Ring Upper 6pcs</p>	<p>FTX6513</p>  <p>Pin 2x10 6pcs</p>
<p>FTX6514</p>  <p>Pin 2x11 6pcs</p>	<p>FTX6223</p>  <p>Hinge Pins (long & short) 1set</p>	<p>FTBB10</p>  <p>Ball Bearing 15x10x4 1pc</p>	<p>FTBB120</p>  <p>Ball Bearing 10x5x4 1pc</p>
<p>FTBB14</p>  <p>Ball Bearing 8x5x2.5 1pc</p>	<p>FTX6515</p>  <p>E-Clip 8mm 4pcs</p>	<p>FTX6516</p>  <p>E-Clip 4mm 4pcs</p>	<p>FTX6517</p>  <p>E-Clip 2.5mm 6pcs</p>
<p>FASTM3</p>  <p>Ny-Lock Nut M3 6pcs</p>	<p>FASTM4</p>  <p>Ny-Lock Nut M4 6pcs</p>	<p>FTX6518</p>  <p>Round Head Self-Tapping Hex Screw 2x10 6pcs</p>	<p>FTX6519</p>  <p>Round Head Self-Tapping Hex Screw 2x10 6pcs</p>



SPARE PARTS LIST

<p>FTX6520</p>  <p>Round Head Self-Tapping Hex Screw 3x12 6pcs</p>	<p>FTX6522</p>  <p>Round Head Self-Tapping Hex Screw M3x6 6pcs</p>	<p>FTX6525</p>  <p>Button Head Hex Screw M3x8 6pcs</p>	<p>FTX6526</p>  <p>Button Head Hex Screw M3x10 6pcs</p>
<p>FTX6527</p>  <p>Button Head Hex Screw M3x12 6pcs</p>	<p>FTX6528</p>  <p>Button Head Hex Screw M3x14 6pcs</p>	<p>FTX6530 FTX6531</p>  <p>Ring Self-Tapping Screw 3x6 6pcs Ring Self-Tapping Screw 3x6 4pcs</p>	<p>FAST122</p>  <p>Set Screw M3x3 6pcs</p>
<p>FAST123</p>  <p>Set Screw M4x4 6pcs</p>	<p>FTX6543</p>  <p>Button Head Hex Screw M4x10 6pcs</p>	<p>FAST114</p>  <p>Cap Head Hex Screw M3x8 6pcs</p>	<p>FTX6542</p>  <p>Cap Head Hex Screw M3x10 6pcs</p>
<p>FAST115</p>  <p>Cap Head Hex Screw M3x10 6pcs</p>	<p>FTX6532</p>  <p>Cap Head Hex Screw M3x14 6pcs</p>	<p>FAST117</p>  <p>Cap Head Hex Screw M3x15 6pcs</p>	<p>FAST118</p>  <p>Cap Head Hex Screw M3x18 6pcs</p>
<p>FAST119</p>  <p>Cap Head Hex Screw M3x25 6pcs</p>	<p>FTX6533</p>  <p>Cap Head Hex Screw M3x28 6pcs</p>	<p>FTX6535</p>  <p>Flat Head Hex Screw M3x8 6pcs</p>	<p>FTX6536</p>  <p>Flat Head Hex Screw M3x10 6pcs</p>



SPARE PARTS LIST

FTX6537	FTX6538	FTX6539	FTX6540
Flat Head Hex Screw M3x12 6pcs	Flat Head Hex Screw M3x14 6pcs	Flat Head Hex Screw M3x18 3pcs	Flat Head Hex Screw M2x20 6pcs
FTX6541	ET1152	ET1106	ET0125
Flat Head Hex Screw M3x36 6pcs	2.4ghz Receiver	2.4GHz Transmitter & Rx 1set	Photon 45Amp ESC 1pc
FTX6557W2	ET0335	FTX6558	VZ0010
60A Waterproof ESC 1pc	2950kv Brushless Motor 1pc	550 Motor Brushed 1pc	Ni-MH 7.2V 1800mAh 1pc
FTX6559W	VZ0305	ET0226T	ET0223
3kg/cm Servo 1pc	Li-Po 3200mAh 7.4V Cell Pack 1pc	USB Charger for NiMH Battery	Li-Po Balance Charger



UPGRADE OPTION PARTS LIST

<p>FTX6351</p>  <p>Carbon Front Shock Plate 1 set</p>	<p>FTX6352</p>  <p>Carbon Rear Shock Plate 1 set</p>	<p>FTX6354</p>  <p>Carbon Battery Cover 1pc</p>	<p>FTX6355</p>  <p>Aluminium Body Post 2pcs</p>
<p>FTX6356</p>  <p>Aluminium Front Shocks 2pcs</p>	<p>FTX6357</p>  <p>Aluminium Rear Shocks 2pcs</p>	<p>FTX6360</p>  <p>Alum. Steering Ackerman 1pc</p>	<p>FTX6361</p>  <p>Alum. Front Susp. Holders 1 set</p>
<p>FTX6362</p>  <p>Alum. Rear Susp. Holders 1 set</p>	<p>FTX6363</p>  <p>Alum. Rear Hub carriers 2pcs</p>	<p>FTX6375</p>  <p>Sway Bar 2 sets</p>	<p>FTX6365</p>  <p>Aluminium Wheel Hub 4pcs</p>
<p>FTX6373</p>  <p>Aluminium Heat Sink 1pc</p>	<p>FTX6366</p>  <p>Wheelie Bar 1 set</p>	<p>FTX6367</p>  <p>Aluminium Steering Arms 2pcs</p>	<p>FTX6368</p>  <p>Aluminium Knuckle Arm 2pcs</p>
<p>FTX6369</p>  <p>Chassis Plate (Alum./Carbon) 1set</p>	<p>FTX6370</p>  <p>Upper Plate (carbon) 1pc</p>	<p>FTX6371</p>  <p>Alum. Lower Susp. Arms 2pcs</p>	<p>FTX6372</p>  <p>Rear Lower Susp. Arms 2pcs</p>

VANTAGE 2.0



www.ftx-rc.com



FTX is an exclusive brand of CML Distribution, Saxon House, Saxon Business Park,
Hanbury Road, Bromsgrove, Worcestershire, B60 4AD England.
E-mail: info@ftx-rc.com