

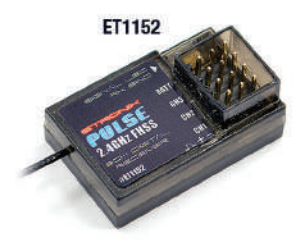

# EXPLODED PARTS DIAGRAM

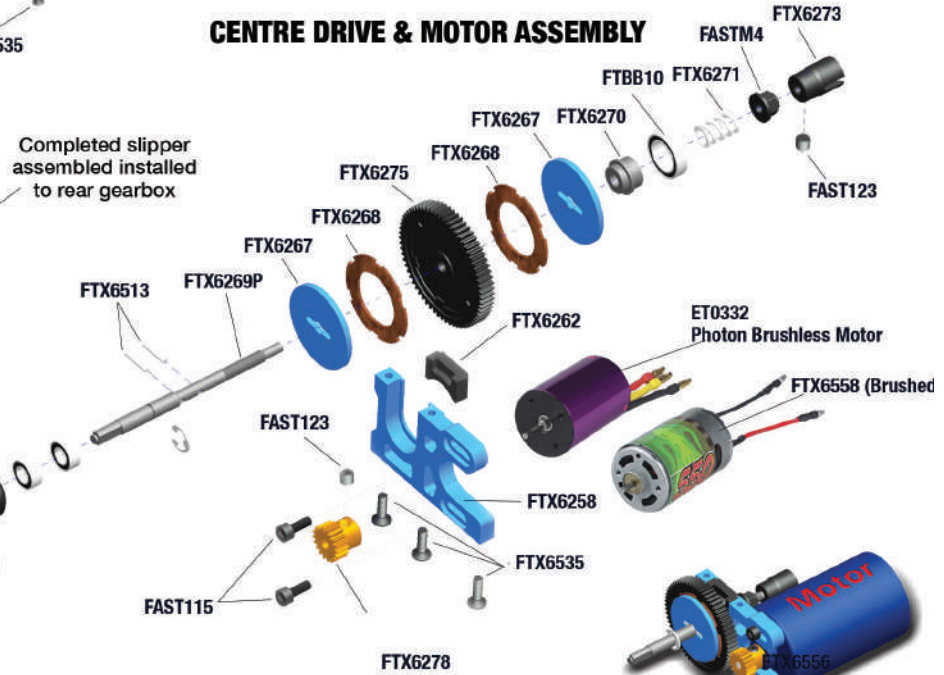

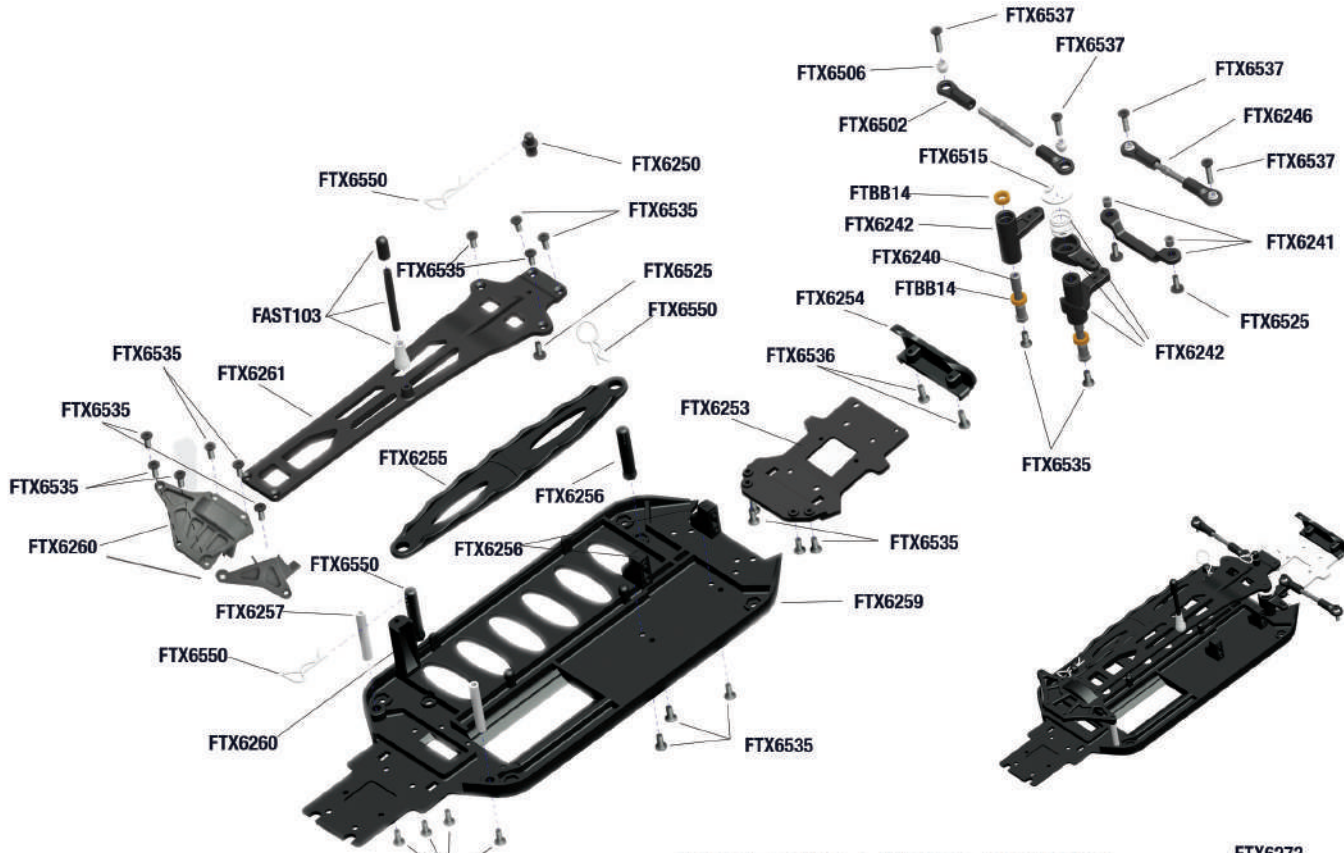

# EXPLODED PARTS DIAGRAM

## FRONT & REAR SHOCK ASSEMBLY

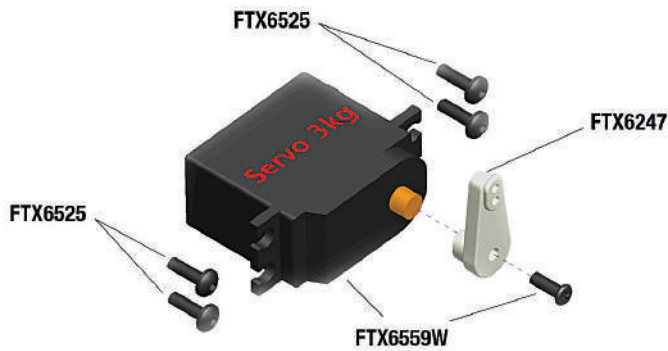
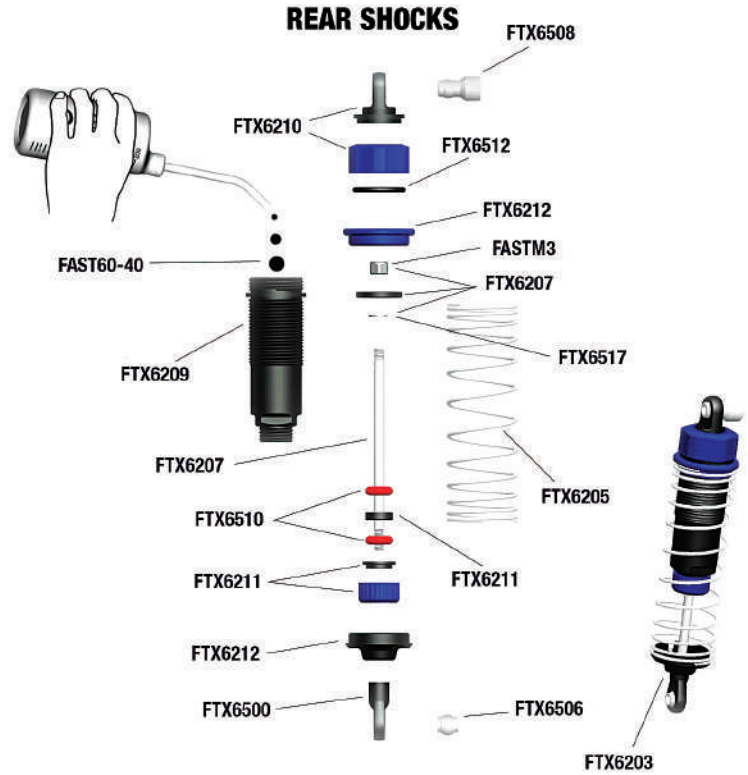
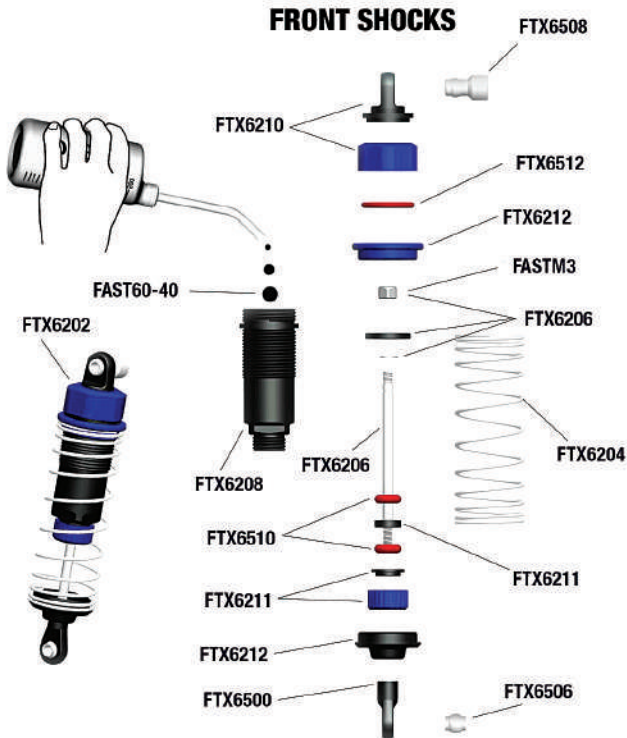

### STEERING SERVO



### FRONT TYRES

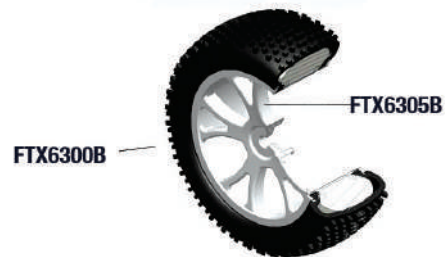

### REAR TYRES





# EXPLODED PARTS DIAGRAM

## B O M

TYPE	ICON	SPEC	QTY
Round Head Self Tapping Hex Screw		2x10	4
Button Head Hex Screw		M3x12	2
Cap Head Hex Screw		M3x8	4
		M3x10	2
		M3x10	10
		M3x12	3
		M3x14	4
		M3x18	2
		M3x36	2
Set Screw		M4x4	1
		M4x10	2
Ring Self Tapping Screw		3x4	2
Washer		ø6xø3.1x0.2	2
Nylon Lock Nut		M3	2
E clip		ø2.5	5
O'Ring		ø6.05xø4.05x1.55	4
		ø6.35xø2.5	4
		ø15.8xø12.0xø1.5	2
Ball Bearing		ø15xø10x4	2
		ø10xø5x4	6

## FRONT ASSEMBLY

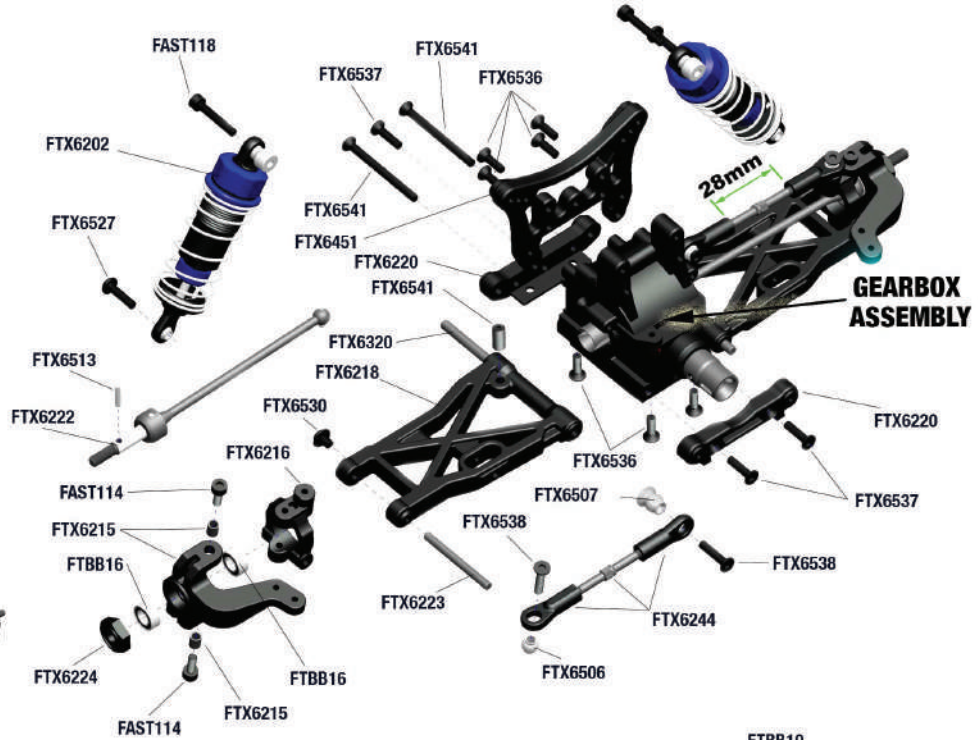

## GEARBOX ASSEMBLY

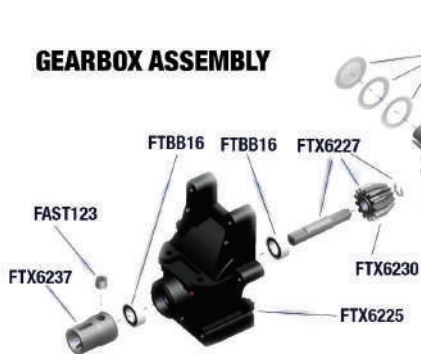

## DIFF. BOX

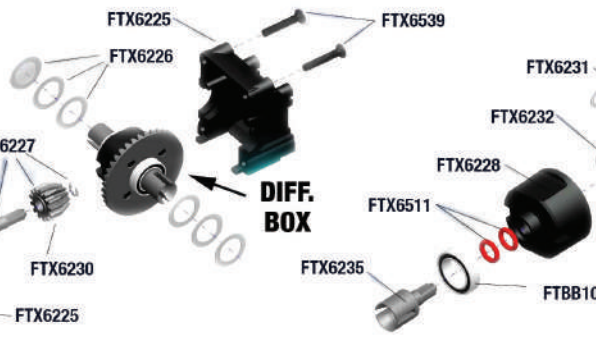

## DIFFERENTIAL BOX

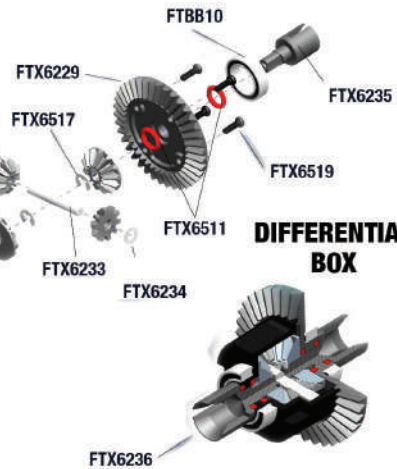

## REAR ASSEMBLY

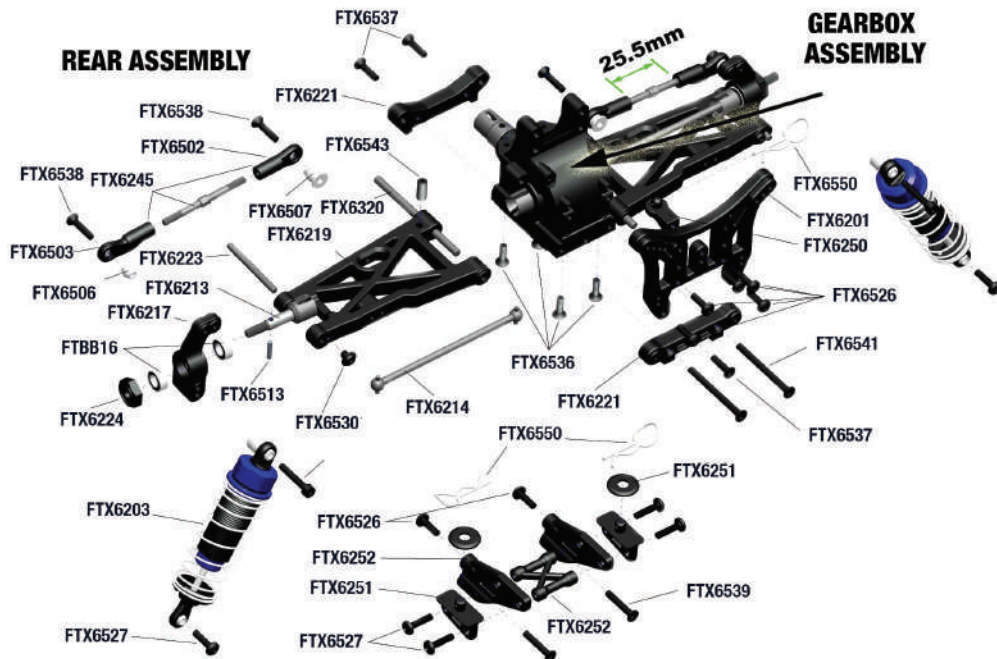

## GEARBOX ASSEMBLY

## B O M

TYPE	ICON	SPEC	QTY
Round Head Self Tapping Hex Screw		2x10	4
Button Head Hex Screw		M3x8	2
		M3x10	7
		M3x12	6
Cap Head Hex Screw		M3x8	2
		M3x10	4
		M3x12	3
Flat Head Hex		M3x10	4
		M3x18	4
		M3x36	2
Set Screw		M4x4	1
		M4x10	2
Ring Self Tapping Screw		3x4	2
Washer		ø6xø3.1x0.2	2
Nylon Lock Nut		M3	3
E clip		ø2.5	5
O'Ring		ø6.05xø4.05x1.55	4
		ø6.35xø2.5	4
		ø15.8xø12.0xø1.5	2
Ball Bearing		ø15xø10x4	2
		ø10xø5x4	6





# EXPLODED PARTS DIAGRAM

<p><b>FTX6450</b></p>  <p>Front Shock Tower 1pc</p>	<p><b>FTX6201</b></p>  <p>Rear Shock Tower 1pc</p>	<p><b>FTX6202</b></p>  <p>Front Shocks 2pcs</p>	<p><b>FTX6203</b></p>  <p>Rear Shocks 2pcs</p>
<p><b>FTX6204</b></p>  <p>Front Shock Spring 2pcs</p>	<p><b>FTX6205</b></p>  <p>Rear Shock Spring 2pcs</p>	<p><b>FTX6206</b></p>  <p>Front Shock Shaft &amp; Piston Set 2 sets</p>	<p><b>FTX6207</b></p>  <p>Rear Shock Shaft &amp; Piston Set 2 sets</p>
<p><b>FTX6208</b></p>  <p>Front Shock Body 2pcs</p>	<p><b>FTX6209</b></p>  <p>Rear Shock Body 2pcs</p>	<p><b>FTX6210</b></p>  <p>Shock Upper Cap 2 Sets</p>	<p><b>FTX6211</b></p>  <p>Shock Lower Cap 2 Sets</p>
<p><b>FTX6212</b></p>  <p>Shock Lower Holder &amp; Adjust Ring 2 sets</p>	<p><b>FTX6215</b></p>  <p>Steering Knuckle Arms 2 sets</p>	<p><b>FTX6216</b></p>  <p>Hub Carrier Uprights 2pcs</p>	<p><b>FTX6217</b></p>  <p>Hub Carrier Uprights 2pcs</p>
<p><b>FTX6213</b></p>  <p>Rear Drive Axles 2pcs</p>	<p><b>FTX6220</b></p>  <p>Front Suspension Holders 2pcs</p>	<p><b>FTX6221</b></p>  <p>Rear Suspension Holders 2pcs</p>	<p><b>FTX6225</b></p>  <p>Gearbox Housing Set 2pcs</p>



# SPARE PARTS LIST

<p><b>FTX6226</b></p>  <p>Diff. 16T Gear Washer 6pcs</p>	<p><b>FTX6227</b></p>  <p>Diff. Gear w/pin 2 sets</p>	<p><b>FTX6236</b></p>  <p>Diff. Gearbox Set 1 set</p>	<p><b>FTX6228</b></p>  <p>Diff. Case 2pcs</p>
<p><b>FTX6229</b></p>  <p>Diff. Drive Spur Gear</p>	<p><b>FTX6230</b></p>  <p>Diff. Drive Gear 2pcs</p>	<p><b>FTX6231</b></p>  <p>Diff. Bevel Gear S. 4pcs</p>	<p><b>FTX6232</b></p>  <p>Diff. Bevel Gear B. 4pcs</p>
<p><b>FTX6233</b></p>  <p>Diff. Pin 2pcs</p>	<p><b>FTX6234</b></p>  <p>Washer 6pcs</p>	<p><b>FTX6235</b></p>  <p>Diff. Drive Cup</p>	<p><b>FTX6237</b></p>  <p>Center Coupler 3pcs</p>
<p><b>FTX6240</b></p>  <p>Servo Saver Posts 2pcs</p>	<p><b>FTX6241</b></p>  <p>Steering Ackerman</p>	<p><b>FTX6224</b></p>  <p>Wheel Hub 4pcs</p>	<p><b>FAST103</b></p>  <p>Antenna Pipe Set 2 sets</p>
<p><b>FTX6300W FTX6300B</b></p>  <p>Front Buggy Tyre Set (pr)</p>	<p><b>FTX6301W FTX6301B</b></p>  <p>Rear Buggy Tyre Set (pr)</p>	<p><b>FTX6305W OR B (FR)</b></p>  <p>Front Rim (pr)</p>	<p><b>FTX6305W OR B (RE)</b></p>  <p>Rear Rim (pr)</p>





# SPARE PARTS LIST

<p><b>FTX6222</b></p>  <p>Front CVD 2 Sets</p>	<p><b>FTX6253</b></p>  <p>Chassis Front part 1pc</p>	<p><b>FTX6254</b></p>  <p>Buggy Front Bumper 1pc</p>	<p><b>FTX6218</b></p>  <p>Front Lower Susp. Arms 2pcs</p>
<p><b>FTX6219</b></p>  <p>Rear Lower Susp. Arms 2pcs</p>	<p><b>FTX6252</b></p>  <p>Wing Bracket 1 set</p>	<p><b>FTX6251</b></p>  <p>Wing Holder 1 set</p>	<p><b>FTX6250</b></p>  <p>Buggy Body Mount 1 set</p>
<p><b>FTX6243</b></p>  <p>Servo Linkage 1pc</p>	<p><b>FTX6244</b></p>  <p>Upper Front Susp. Arm 2 sets</p>	<p><b>FTX6245</b></p>  <p>Rear Upper Arm 2 sets</p>	<p><b>FTX6246</b></p>  <p>Steering Arm 2 sets</p>
<p><b>FTX6214</b></p>  <p>Central Dogbone F. 1pc</p>	<p><b>FTX6255</b></p>  <p>Battery Cover (EP) 1pc</p>	<p><b>FTX6256</b></p>  <p>Battery Posts 2 sets</p>	<p><b>FTX6257</b></p>  <p>Rear Spur Gear Cover Post 2pc</p>
<p><b>FTX6258</b></p>  <p>Motor Mount (EP) 1pc</p>	<p><b>FTX6266</b></p>  <p>Slipper Complete (EP) 1 set</p>	<p><b>FTX6267</b></p>  <p>Slipper Pad (EP) 2pcs</p>	<p><b>FTX6268</b></p>  <p>Slipper Gasket (EP) 2pcs</p>
<p><b>FTX6275</b></p>  <p>Spur Gear (EP) 65T 1pc</p>			



# SPARE PARTS LIST

<p><b>FTX6269P</b></p>  <p><b>Slipper Shaft (EP) 1 set</b></p>	<p><b>FTX6270</b></p>  <p><b>Slipper Spring Bracket (EP) 1pc</b></p>	<p><b>FTX6271</b></p>  <p><b>Slipper Spring (EP) 1pc</b></p>	<p><b>FTX6242</b></p>  <p><b>Servo Saver (EP) 1 set</b></p>
<p><b>FTX6273</b></p>  <p><b>Slipper Drive Cup 1pc</b></p>	<p><b>FTX6262</b></p>  <p><b>Bearing Bracket (EP) 1pc</b></p>	<p><b>FTX6278</b></p>  <p><b>Pinion Gear (EP) 23T 1pc</b></p>	
<p><b>FTX6259</b></p>  <p><b>Chassis Plate (EP) 1pc</b></p>	<p><b>FTX6260</b></p>  <p><b>Rear Spur Gear Cover (EP) 1pc</b></p>	<p><b>FTX6261</b></p>  <p><b>Upper Plate (EP) 1pc</b></p>	<p><b>FTX6265</b></p>  <p><b>Center Drive Shaft (EP) 1pc</b></p>
<p><b>FTX6550</b></p>  <p><b>Body Clip (med) 6pcs</b></p>	<p><b>FTX6551</b></p>  <p><b>Body Clip (small) 6pcs</b></p>	<p><b>FTX6500</b></p>  <p><b>Shock Ball End 6pcs</b></p>	<p><b>FTX6501</b></p>  <p><b>Servo link Ball End 6pcs</b></p>
<p><b>FTX6502</b></p>  <p><b>Steering Link Ball End 6pcs</b></p>	<p><b>FTX6503</b></p>  <p><b>Rear Upper Link Ball End 6pcs</b></p>	<p><b>FTX6504</b></p>  <p><b>Sway Bar Fix Plate 6pcs</b></p>	<p><b>FTX6505</b></p>  <p><b>Sway Bar Holders 6pcs</b></p>























# SPARE PARTS LIST

<b>FTX6506</b>  Ball A 6pcs	<b>FTX6507</b>  Ball B 6pcs	<b>FTX6508</b>  Ball C 6pcs	<b>FTX6509</b>  Ball D 6pcs
<b>FTX6510</b>  Shock O-Ring Lower 6pcs	<b>FTX6511</b>  Diff. O-Ring Seal 6pcs	<b>FTX6512</b>  Shock O-Ring Upper 6pcs	<b>FTX6513</b>  Pin 2x10 6pcs
<b>FTX6514</b>  Pin 2x11 6pcs	<b>FTX6223</b>  Hinge Pins (long & short) 1set	<b>FTBB10</b>  Ball Bearing 15x10x4 1pc	<b>FTBB120</b>  Ball Bearing 10x5x4 1pc
<b>FTBB14</b>  Ball Bearing 8x5x2.5 1pc	<b>FTX6515</b>  E-Clip 8mm 4pcs	<b>FTX6516</b>  E-Clip 4mm 4pcs	<b>FTX6517</b>  E-Clip 2.5mm 6pcs
<b>FASTM3</b>  Ny-Lock Nut M3 6pcs	<b>FASTM4</b>  Ny-Lock Nut M4 6pcs	<b>FTX6518</b>  Round Head Self-Tapping Hex Screw 2x10 6pcs	<b>FTX6519</b>  Round Head Self-Tapping Hex Screw 2x10 6pcs

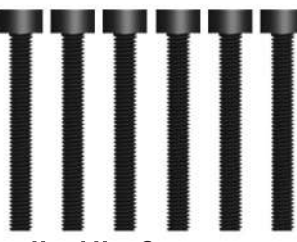

# SPARE PARTS LIST

<p><b>FTX6520</b></p>  <p>Round Head Self-Tapping Hex Screw 3x12 6pcs</p>	<p><b>FTX6522</b></p>  <p>Round Head Self-Tapping Hex Screw M3x6 6pcs</p>	<p><b>FTX6525</b></p>  <p>Button Head Hex Screw M3x8 6pcs</p>	<p><b>FTX6526</b></p>  <p>Button Head Hex Screw M3x10 6pcs</p>
<p><b>FTX6527</b></p>  <p>Button Head Hex Screw M3x12 6pcs</p>	<p><b>FTX6528</b></p>  <p>Button Head Hex Screw M3x14 6pcs</p>	<p><b>FTX6530</b>   <b>FTX6531</b></p>  <p>Ring Self-Tapping Screw 3x6 6pcs Ring Self-Tapping Screw 3x6 4pcs</p>	<p><b>FAST122</b></p>  <p>Set Screw M3x3 6pcs</p>
<p><b>FAST123</b></p>  <p>Set Screw M4x4 6pcs</p>	<p><b>FTX6543</b></p>  <p>Button Head Hex Screw M4x10 6pcs</p>	<p><b>FAST114</b></p>  <p>Cap Head Hex Screw M3x8 6pcs</p>	<p><b>FTX6542</b></p>  <p>Cap Head Hex Screw M3x10 6pcs</p>
<p><b>FAST115</b></p>  <p>Cap Head Hex Screw M3x10 6pcs</p>	<p><b>FTX6532</b></p>  <p>Cap Head Hex Screw M3x14 6pcs</p>	<p><b>FAST117</b></p>  <p>Cap Head Hex Screw M3x15 6pcs</p>	<p><b>FAST118</b></p>  <p>Cap Head Hex Screw M3x18 6pcs</p>
<p><b>FAST119</b></p>  <p>Cap Head Hex Screw M3x25 6pcs</p>	<p><b>FTX6533</b></p>  <p>Cap Head Hex Screw M3x28 6pcs</p>	<p><b>FTX6535</b></p>  <p>Flat Head Hex Screw M3x8 6pcs</p>	<p><b>FTX6536</b></p>  <p>Flat Head Hex Screw M3x10 6pcs</p>



# SPARE PARTS LIST

FTX6537	FTX6538	FTX6539	FTX6540
Flat Head Hex Screw M3x12 6pcs	Flat Head Hex Screw M3x14 6pcs	Flat Head Hex Screw M3x18 3pcs	Flat Head Hex Screw M2x20 6pcs
FTX6541	ET1152	ET1106	ET0125
Flat Head Hex Screw M3x36 6pcs	2.4ghz Receiver	2.4GHz Transmitter & Rx 1set	Photon 45Amp ESC 1pc
FTX6557W2	ET0335	FTX6558	VZ0010
60A Waterproof ESC 1pc	2950kv Brushless Motor 1pc	550 Motor Brushed 1pc	Ni-MH 7.2V 1800mAh 1pc
FTX6559W	VZ0305	ET0226T	ET0223
3kg/cm Servo 1pc	Li-Po 3200mAh 7.4V Cell Pack 1pc	USB Charger for NiMH Battery	Li-Po Balance Charger





# UPGRADE OPTION PARTS LIST

<p><b>FTX6351</b></p>  <p><b>Carbon Front Shock Plate 1 set</b></p>	<p><b>FTX6352</b></p>  <p><b>Carbon Rear Shock Plate 1 set</b></p>	<p><b>FTX6354</b></p>  <p><b>Carbon Battery Cover 1pc</b></p>	<p><b>FTX6355</b></p>  <p><b>Aluminium Body Post 2pcs</b></p>
<p><b>FTX6356</b></p>  <p><b>Aluminium Front Shocks 2pcs</b></p>	<p><b>FTX6357</b></p>  <p><b>Aluminium Rear Shocks 2pcs</b></p>	<p><b>FTX6360</b></p>  <p><b>Alum. Steering Ackerman 1pc</b></p>	<p><b>FTX6361</b></p>  <p><b>Alum. Front Susp. Holders 1 set</b></p>
<p><b>FTX6362</b></p>  <p><b>Alum. Rear Susp. Holders 1 set</b></p>	<p><b>FTX6363</b></p>  <p><b>Alum. Rear Hub carriers 2pcs</b></p>	<p><b>FTX6375</b></p>  <p><b>Sway Bar 2 sets</b></p>	<p><b>FTX6365</b></p>  <p><b>Aluminium Wheel Hub 4pcs</b></p>
<p><b>FTX6373</b></p>  <p><b>Aluminium Heat Sink 1pc</b></p>	<p><b>FTX6366</b></p>  <p><b>Wheelie Bar 1 set</b></p>	<p><b>FTX6367</b></p>  <p><b>Aluminium Steering Arms 2pcs</b></p>	<p><b>FTX6368</b></p>  <p><b>Aluminium Knuckle Arm 2pcs</b></p>
<p><b>FTX6369</b></p>  <p><b>Chassis Plate (Alum./Carbon) 1set</b></p>	<p><b>FTX6370</b></p>  <p><b>Upper Plate (carbon) 1pc</b></p>	<p><b>FTX6371</b></p>  <p><b>Alum. Lower Susp. Arms 2pcs</b></p>	<p><b>FTX6372</b></p>  <p><b>Rear Lower Susp. Arms 2pcs</b></p>



# VANTAGE 2.0

## OPTIONAL EXTRAS

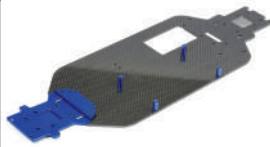

**FTX6369 – FTX VANTAGE CHASSIS PLATE (AL.+CARBON) 1SET**



**FTX6351 – FTX VANTAGE CARBON FRONT SHOCK TOWER**



**FTX6352 – FTX VANTAGE CARBON REAR SHOCK TOWER**



**FTX6353 – FTX VANTAGE CARBON TOP PLATE**



**FTX6354 – FTX VANTAGE BATTERY COVER (CARBON) (1PC)**



**FTX6371 – FTX VANTAGE FRONT LOWER SUSP. ARM (AL.) 2PCS**



**FTX6356 – FTX VANTAGE ALUMINIUM FRONT SHOCK (2PCS)**



**FTX6357 – FTX VANTAGE ALUM. REAR SHOCK (2PCS)**



**FTX6372 – FTX VANTAGE REAR LOWER SUSP. ARM (AL.) 2PCS**



**FTX6374 – FTX VANTAGE & ZORRO ALUMINIUM FRONT PLATE**



**FTX6360 – FTX VANTAGE ALUM. STEERING ACKERMAN (1PC)**



**FTX6361 – FTX CARNAGE 2.0 AL. FRONT SUSP. HOLDERS (1SET)**



**FTX6362 – FTX CARNAGE 2.0 ALUM. REAR SUSP. HOLDERS 1SET**



**FTX6363 – FTX CARNAGE 2.0 ALUM REAR HUB CARRIER (2PCS)**



**FTX6365 – FTX CARNAGE 2.0 ALUMINIUM WHEEL HUB (4PCS)**



**FTX6375/6 – FTX VANTAGE SWAY BAR 2 SETS**



**FTX6367 – FTX CARNAGE 2.0 ALUM. STEERING ARMS (2PCS)**



**FTX6368 – FTX CARNAGE 2.0 ALUMINIUM KNUCKLE ARMS (2PCS)**



**FTX6387 – FTX VANTAGE PRO FRONT CARBON SHOCK TOWER**



**FTX6388 – FTX VANTAGE PRO REAR CARBON SHOCK TOWER**

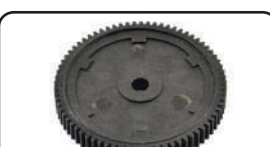

**FTX6392 – FTX 48DP 73T SPUR GEAR CONVERSION – CARNAGE 2.0**

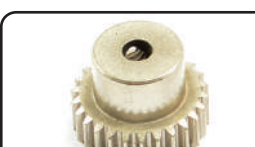

**FTX6394 – FTX 48DP 26T PINION GEAR CONVERSION FOR VANTAGE**



**FTM48F – FASTRAX M4 BLUE FLANGED LOCKNUTS (4PCS)**



**VZ0015 – VOLTZ 3000MAH NIMH STICK BATTERY PACK 7.2V**



**ET2069 – ETRONIX 15KG/0.165 DIGI WATERPROOF SERVO**

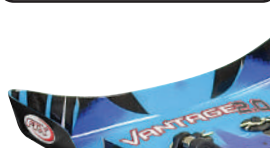

**VZ0020 – VOLTZ 4600MAH 7.2V NIMH STICK PACK BATTERY**



**ET0209 – ETRONIX POWERPAL PEAK+ AC NIMH, LIPO CHARGER**



**ET0204 – ETRONIX POWERPAL MINI 60W BALANCE DIS/CHARGER**



FTX, VOLTZ AND ETRONIX ARE DIVISIONS OF CML DISTRIBUTION LIMITED. SAXON HOUSE, SAXON BUSINESS PARK, HANBURY ROAD, BROMSGROVE, WORCESTERSHIRE. B60 4AD. EMAIL: INFO@FTX-RC.COM WEB: FTX-RC.COM

**ETRONIX**  
MODEL ELECTRONICS

**VOLTZ**



WWW.FTX-RC.COM