

galeón  
galleon  
**San Martín**

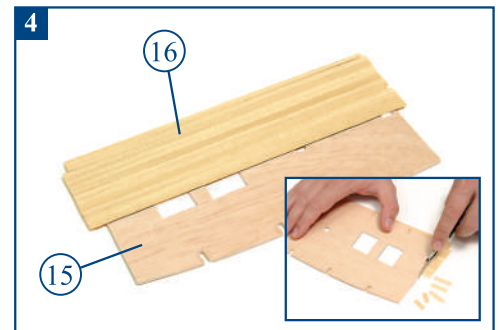

Ref.: 13601

**Casco / Hull / Scafo / Rumpf**

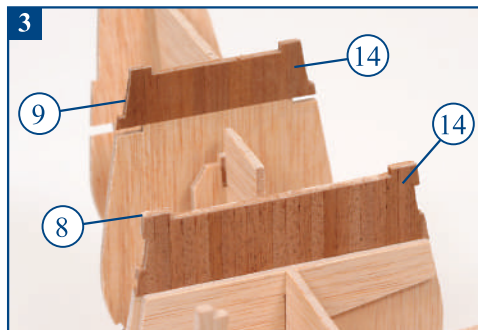
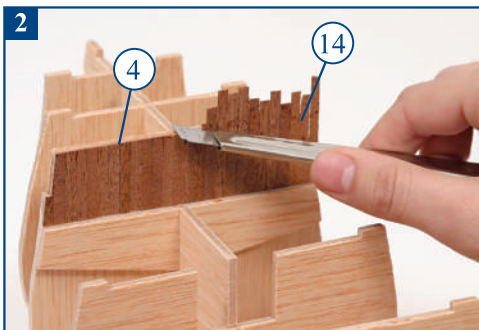
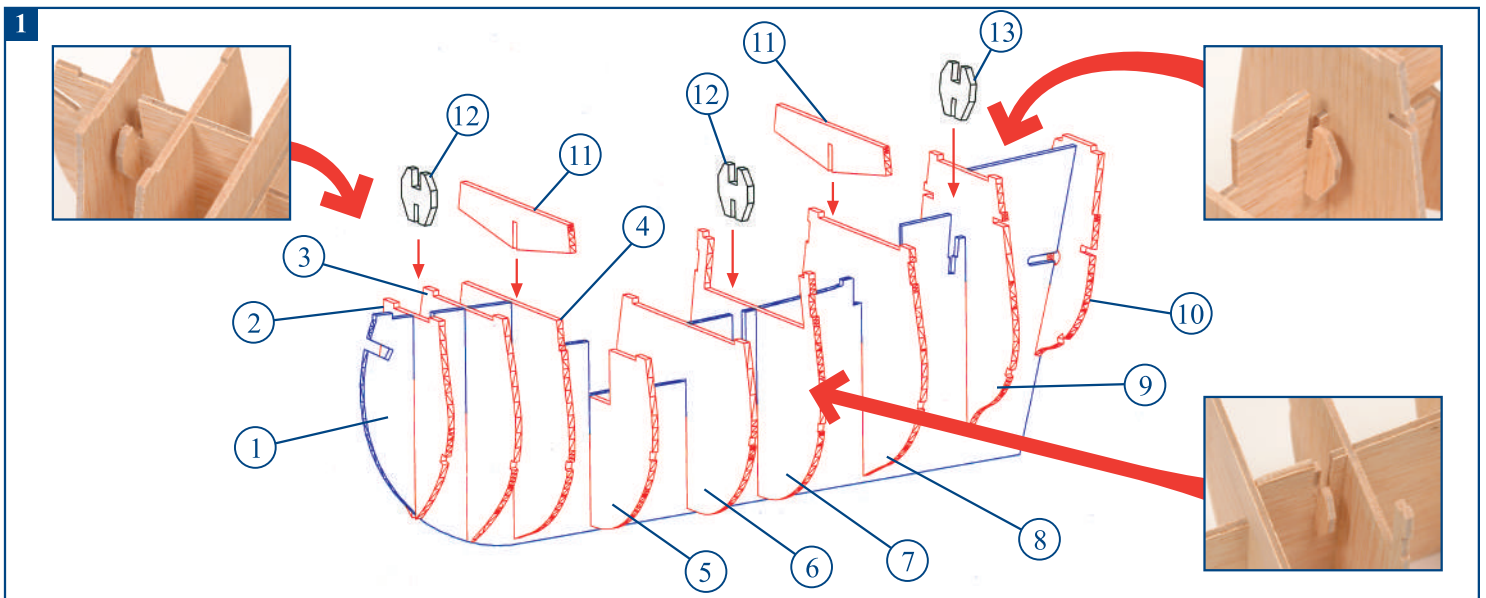

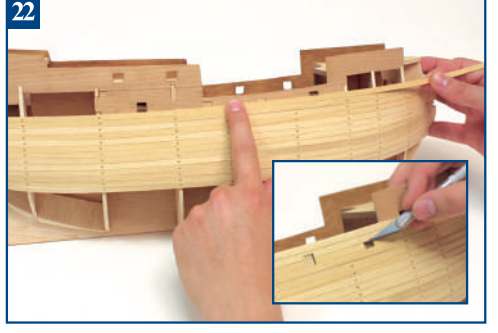
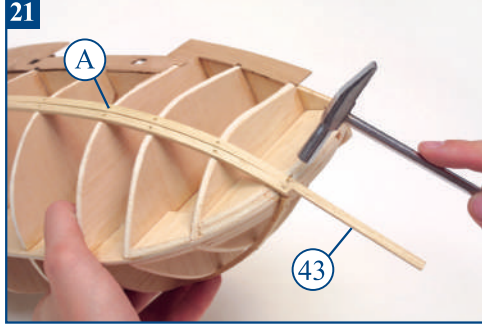
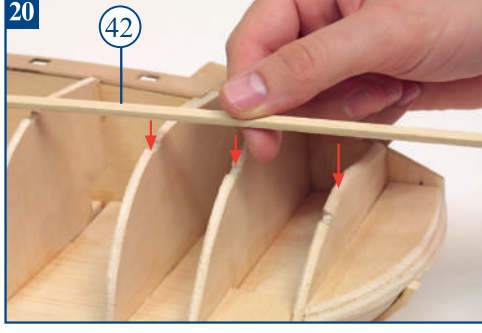
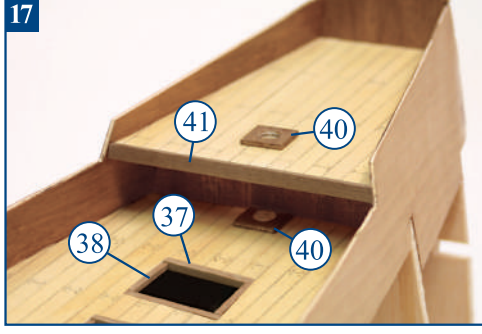
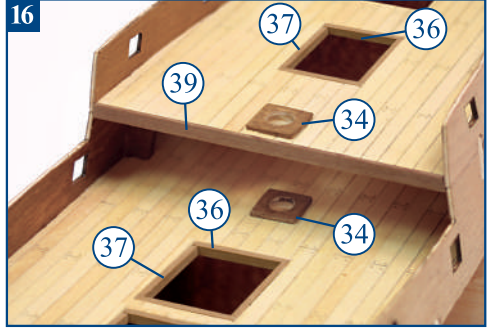
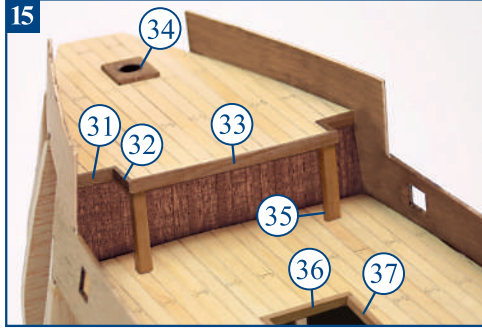
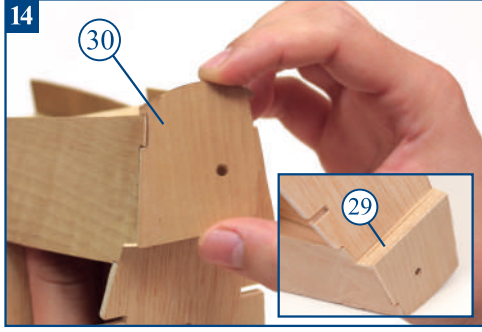
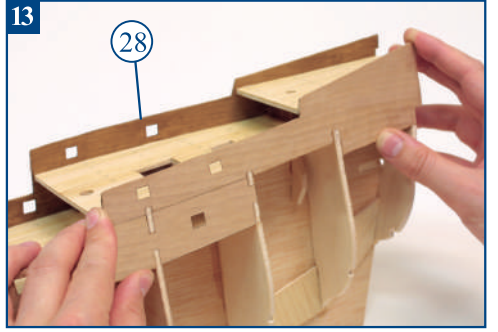
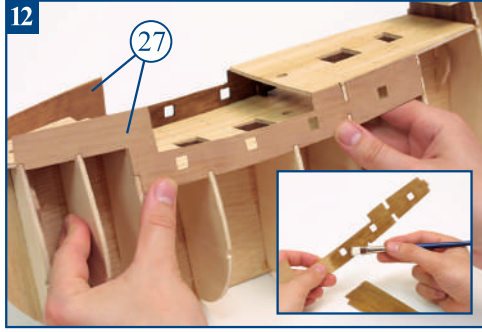
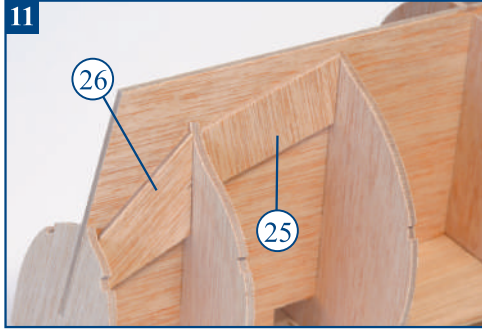
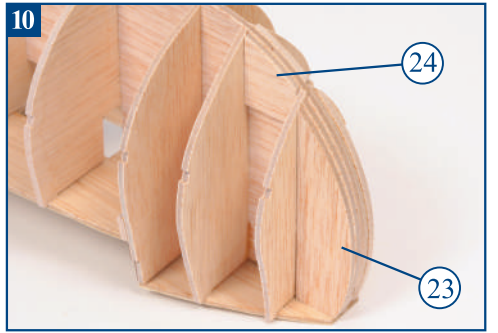
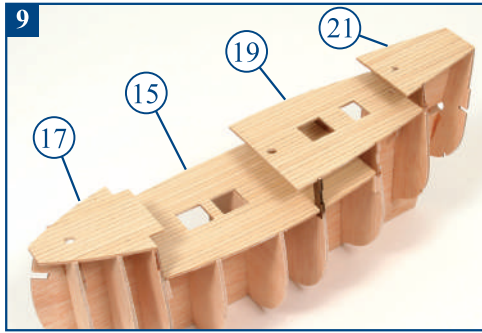
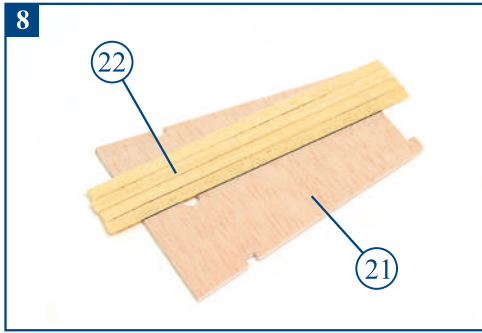
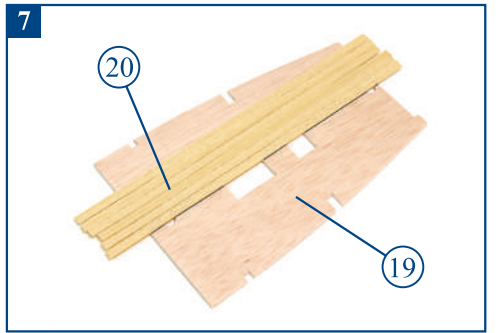
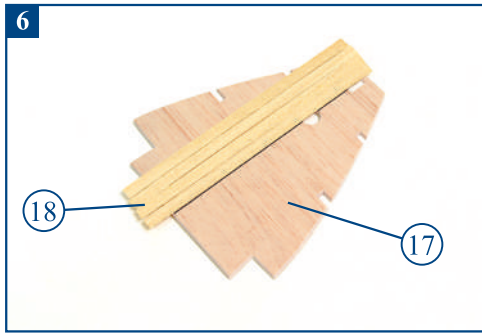
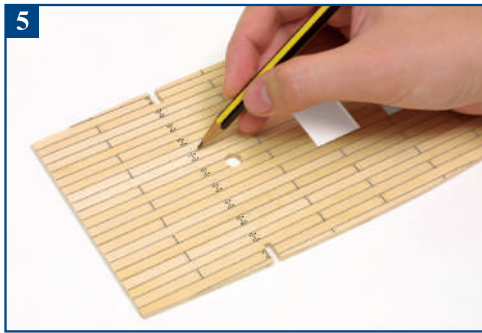

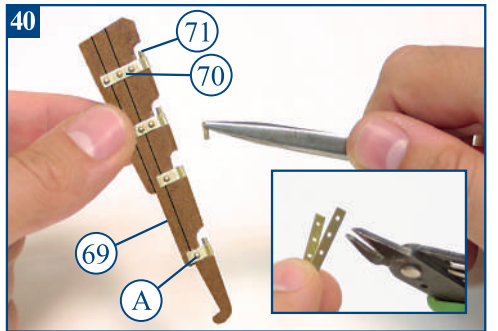
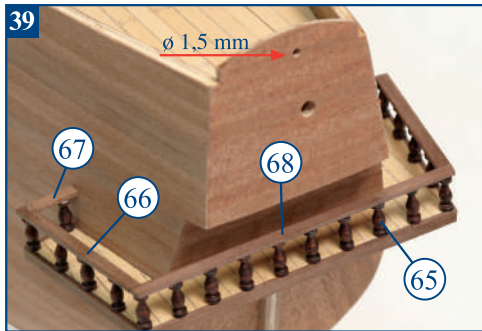
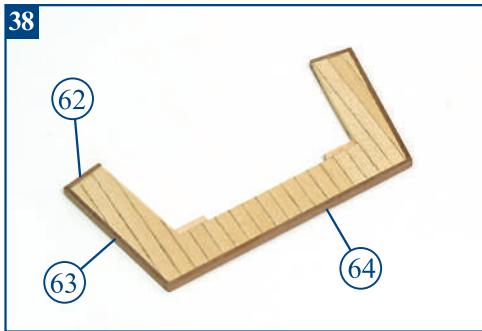
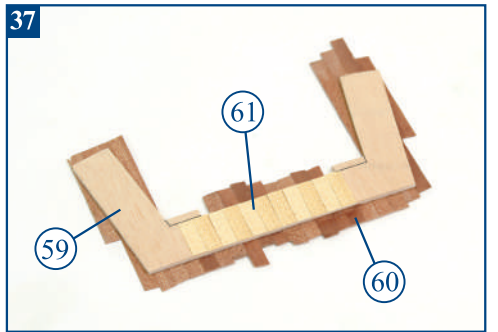
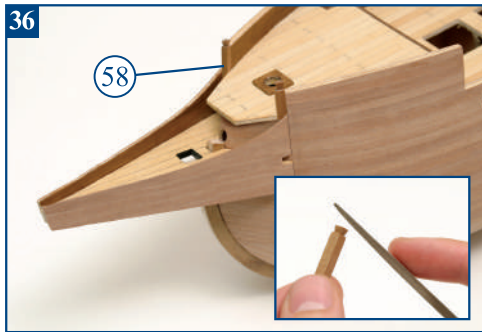
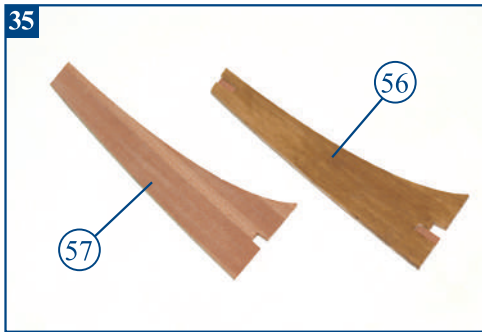
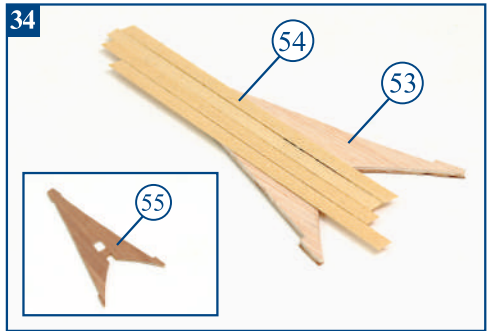
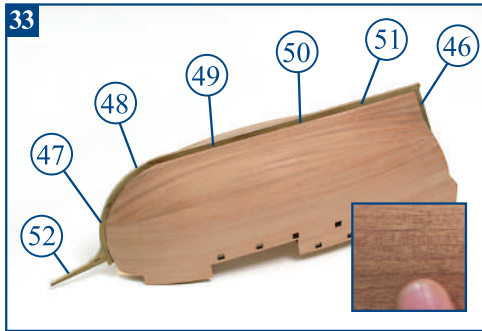
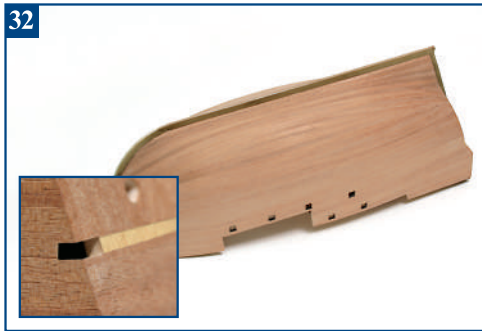
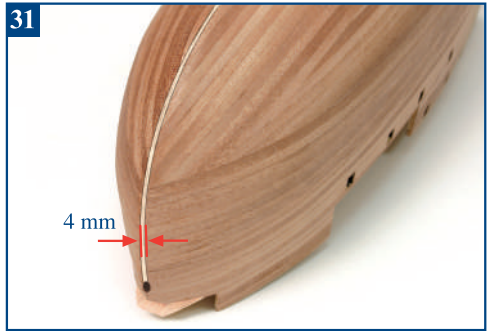
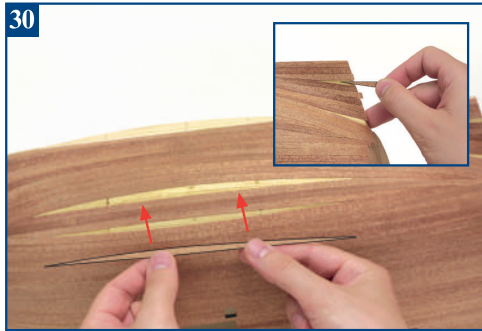
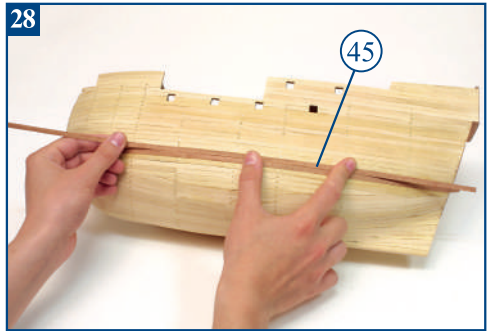
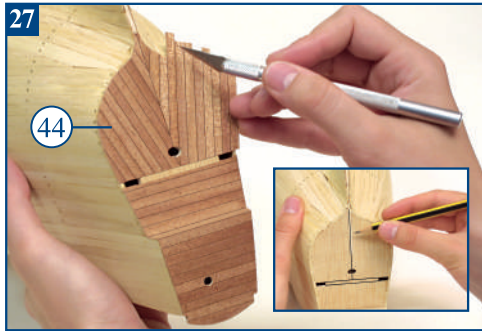
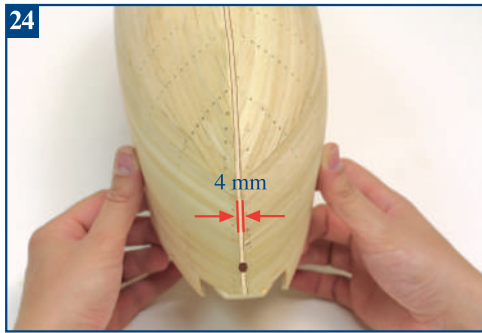
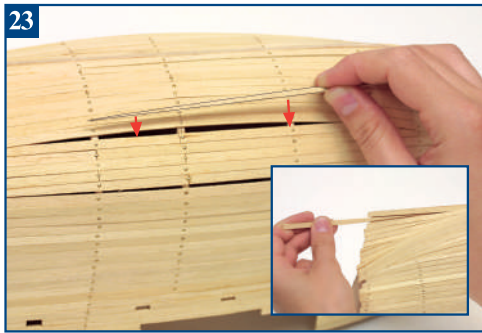

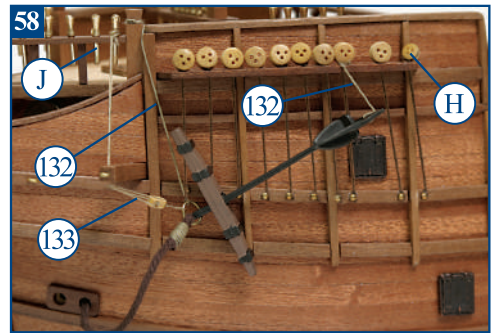
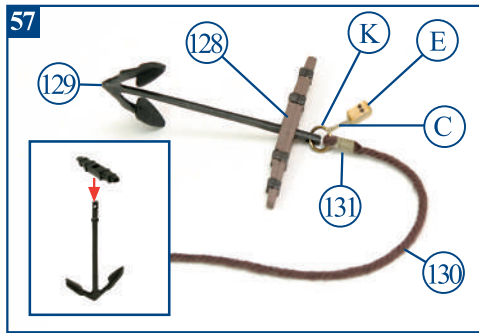
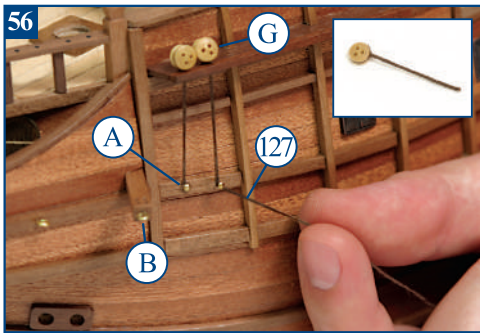
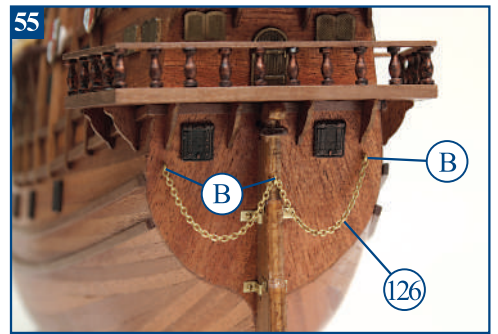
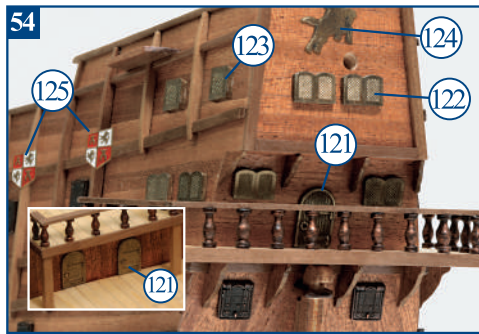
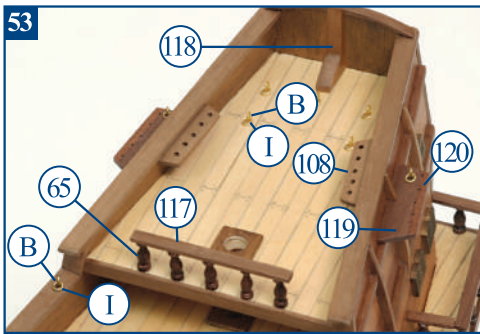
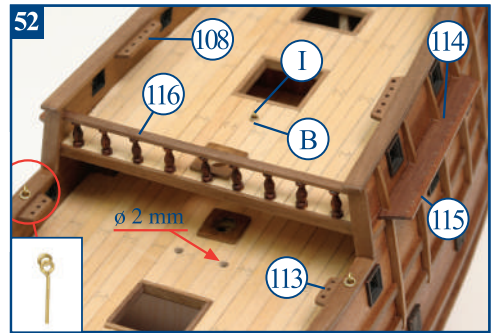
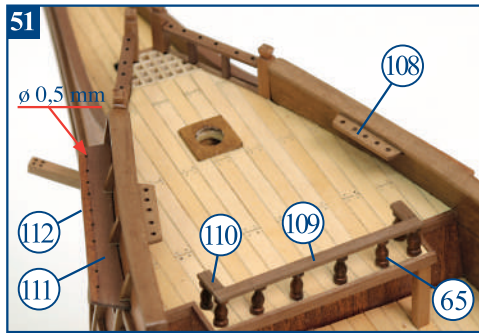
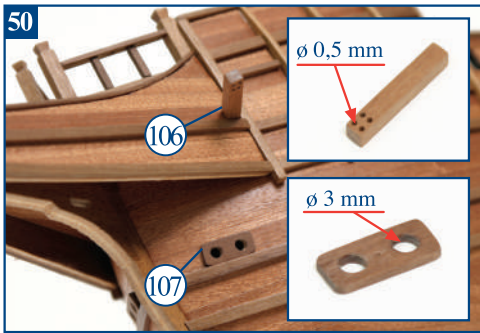
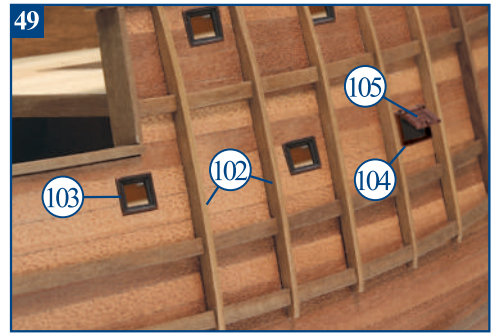
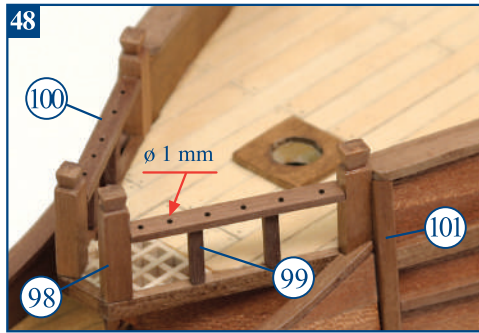
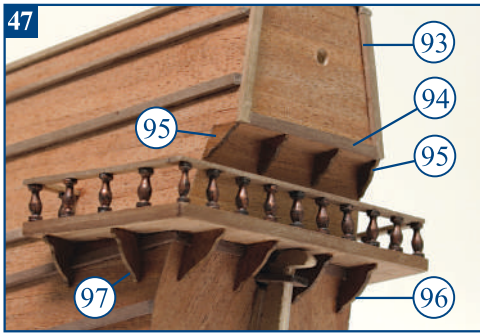
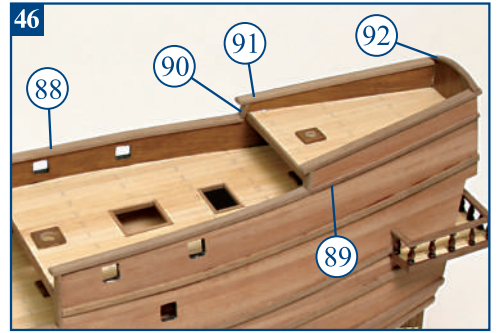
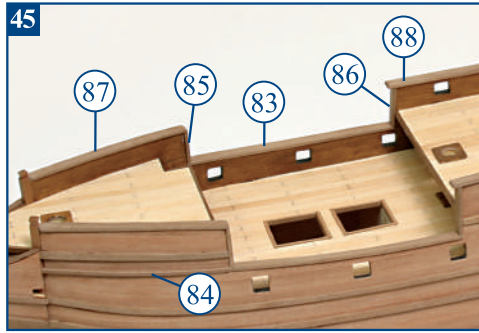
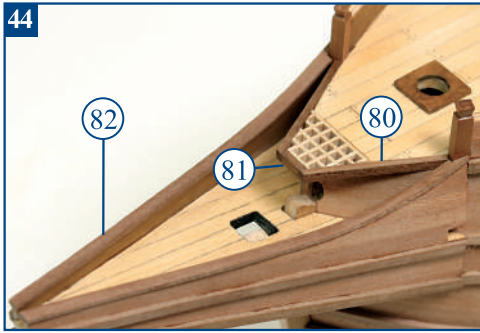
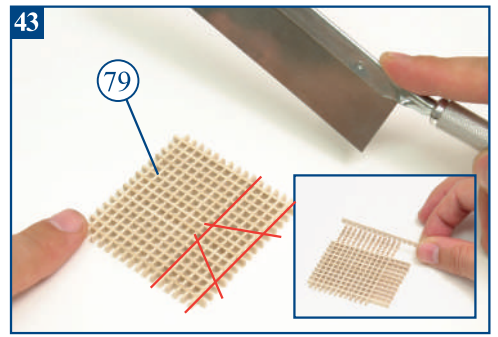
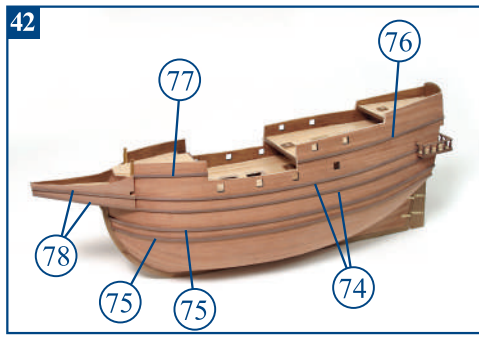
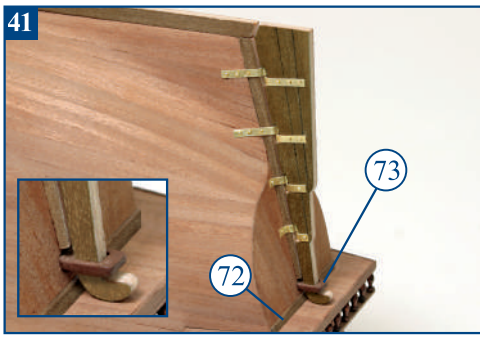



# Palo trinquete / Fore mast / Albero trinchetto / Fockmast

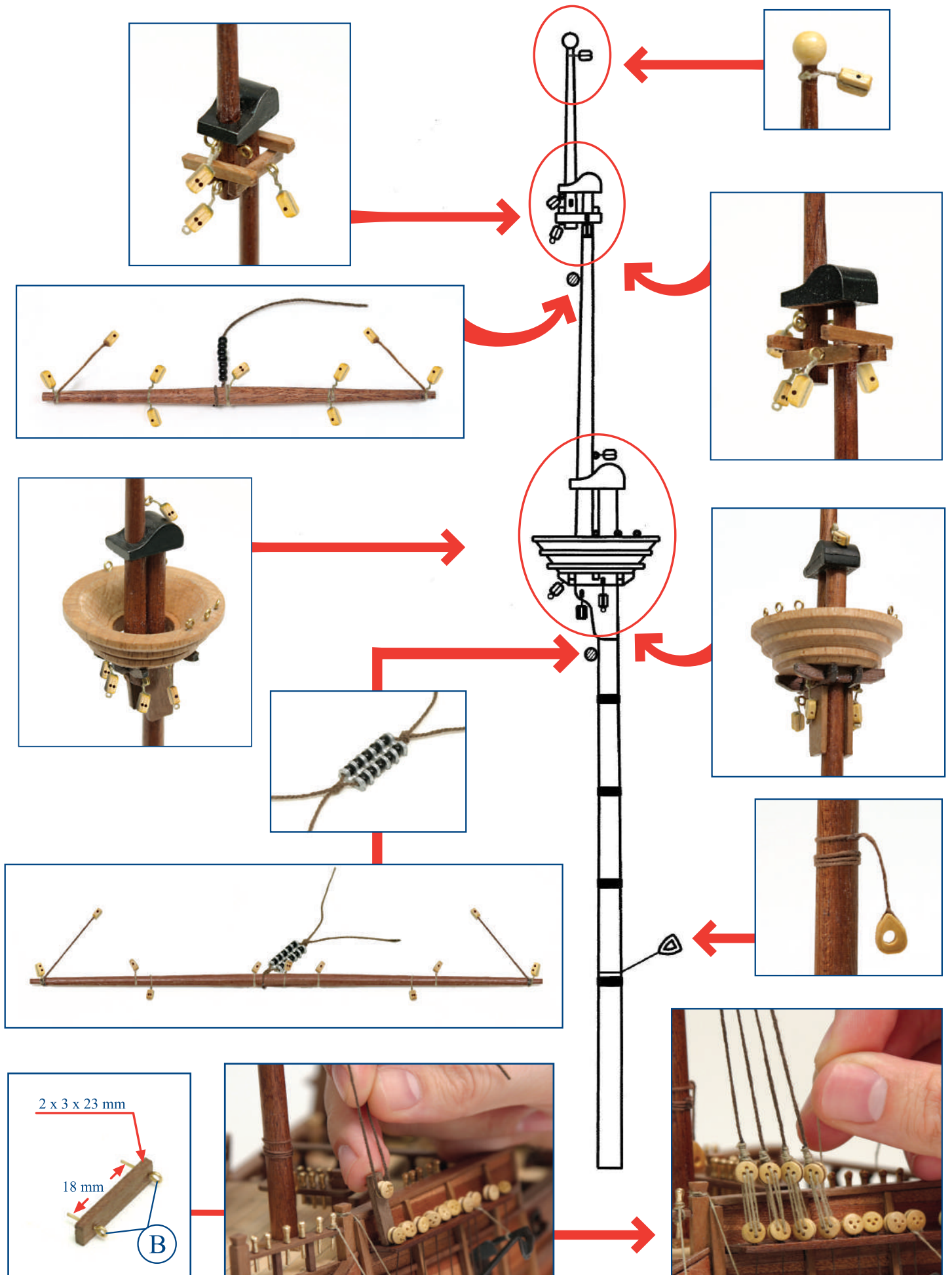

# Palo mayor / Main mast / Albero maestro / Hauptmast

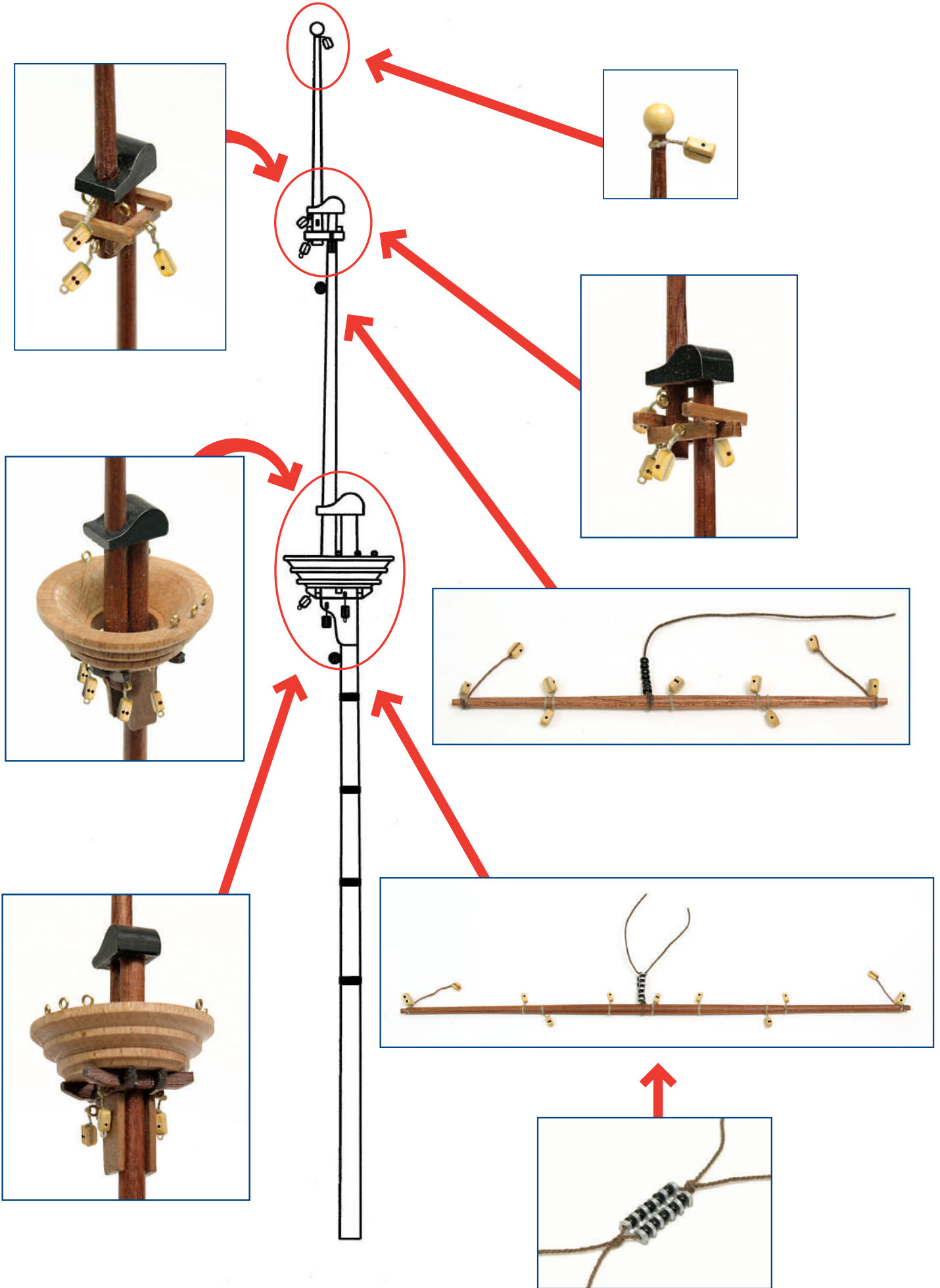

# Palo mesana / Mizze mast / Albero mezzana / Kreuzmast

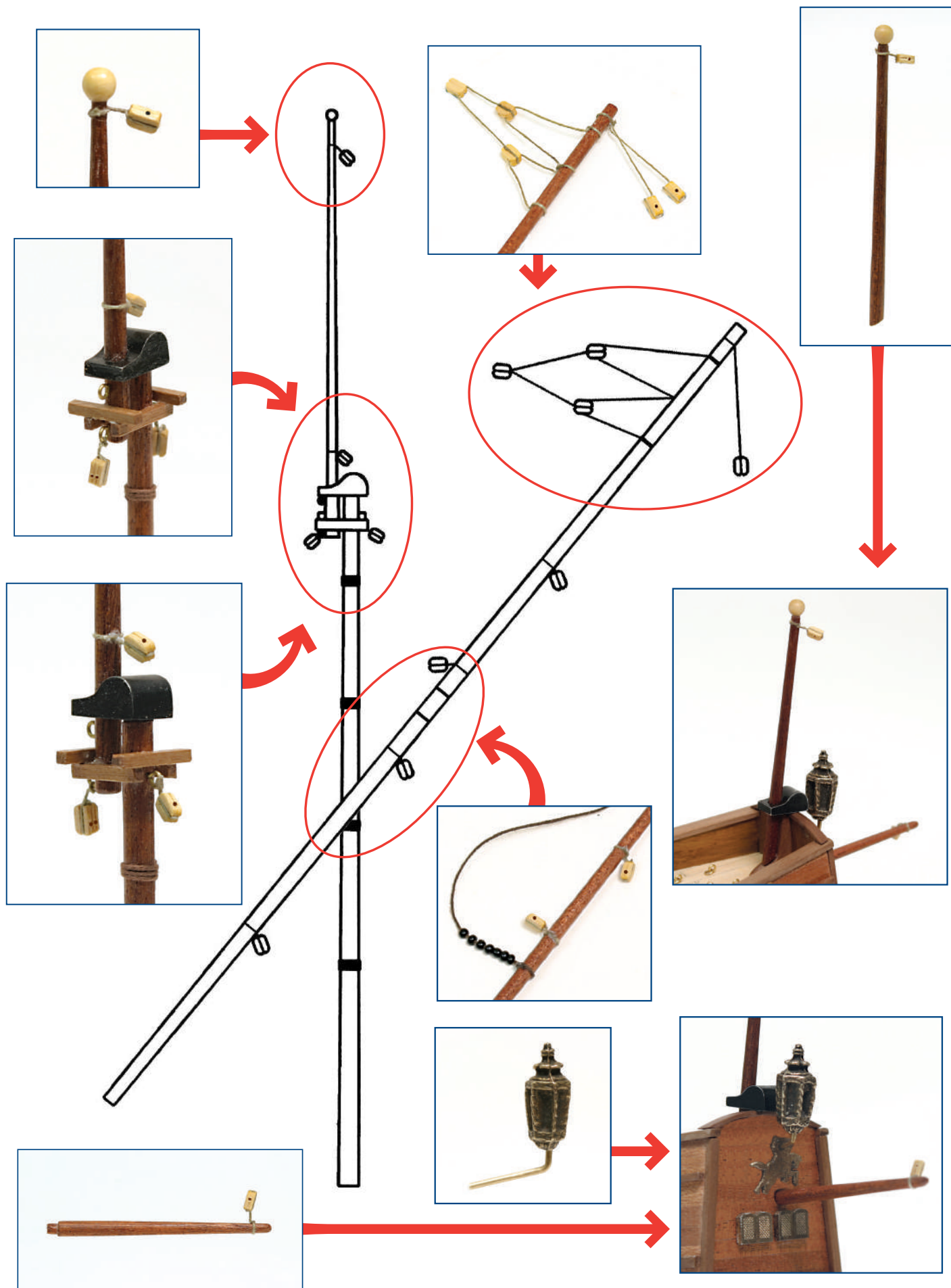

# Listado de piezas

Nº	Descripción	Cantidad	Medidas	Material
196	Trincha del bauprés	1	ø0,50x200	Hilo algodón
197	Obenques trinquete (marrón) DOBLES	9	ø0,50x300	Hilo algodón
198	Acolladores (crudo)	62	ø0,15x200	Hilo algodón
199	Flechastes (crudo)	144	ø0,15x100	Hilo algodón
200	Obenquillos mastelero trinquete (marrón) DOBLES	3	ø0,50x175	Hilo algodón
201	Obenques del mayor (marrón) DOBLES	11	ø0,50x350	Hilo algodón
202	Obenquillos mastelero mayor (marrón)	3	ø0,50x220	Hilo algodón
203	Obenques mesana (marrón) DOBLES	5	ø0,50x215	Hilo algodón
G	Vigota ø5mm	80	ø5	Madera
H	Vigota ø41mm	44	ø4	Madera

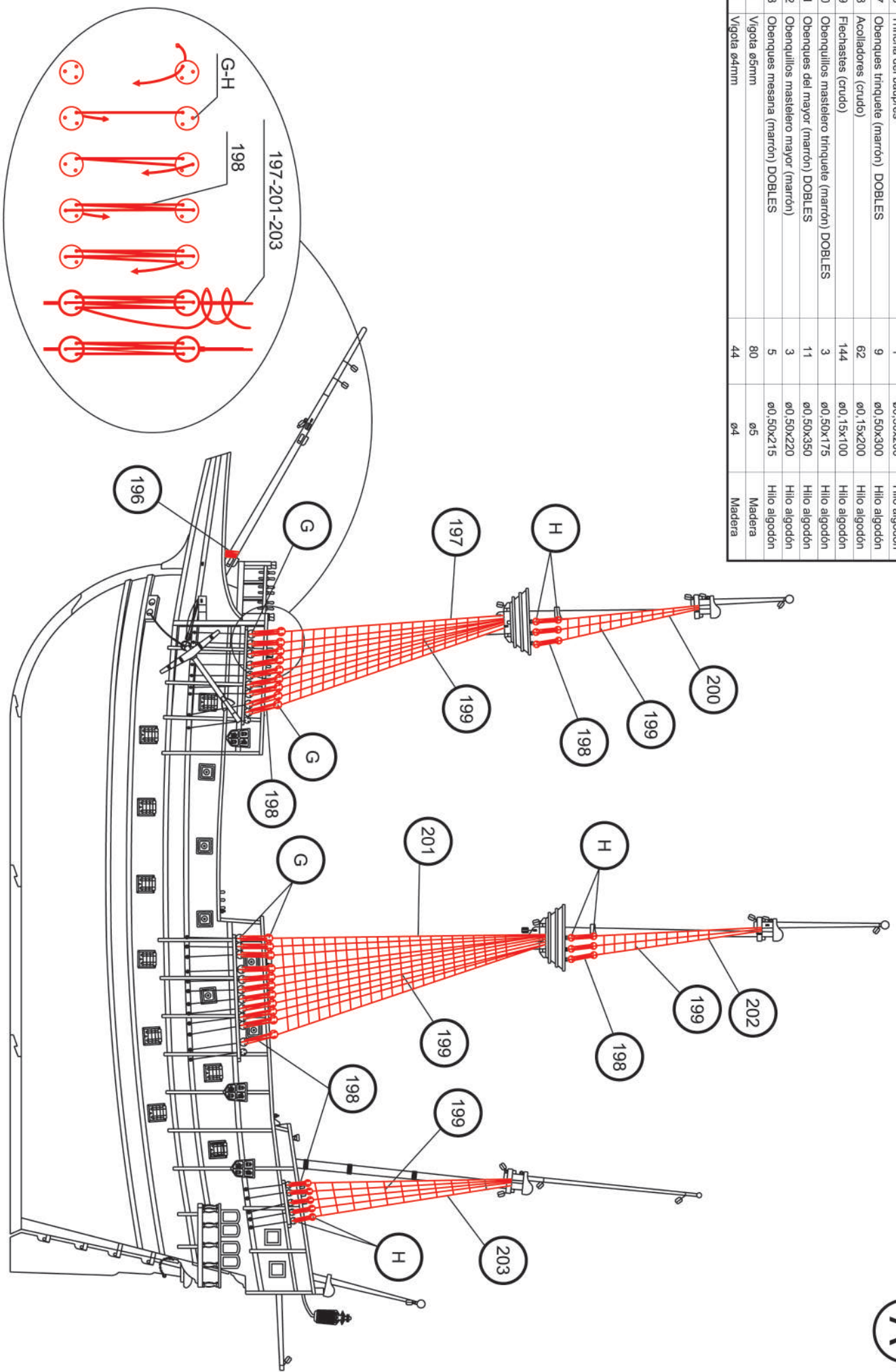

## Listado de piezas

Nº	Descripción	Cantidad	Medidas	Material
198	Acolladores (crudo)	4	ø0,15x200	Hilo algodón
204	Estay de trinquele (marrón)	1	ø0,50x235	Hilo algodón
205	Estay doble de galope (marrón)	1	ø0,50x315	Hilo algodón
206	Aparejo driza estay de galope (crudo)	1	ø0,15x100	Hilo algodón
207	Driza estay de galope (crudo)	1	ø0,15x280	Hilo algodón
208	Estay del mayor (marrón)	1	ø0,50x320	Hilo algodón
209	Estay de gavia (marrón)	1	ø0,50x285	Hilo algodón
210	Estay de mesana (marrón)	1	ø0,50x270	Hilo algodón
211	Burdas del trinquele (dobles/marrón)	1	ø0,50x200	Hilo algodón
212	Burdas del mayor (dobles/marrón)	1	ø0,50x275	Hilo algodón
213	Burdas del mesana (dobles/marrón)	1	ø0,50x220	Hilo algodón
214	Vientos del bauprés (marrón)	2	ø0,50x200	Hilo algodón
D	Motón	3	4	Madera
H	Vigota	8	ø4	Madera
F	Vigota ciega	1	7	Madera

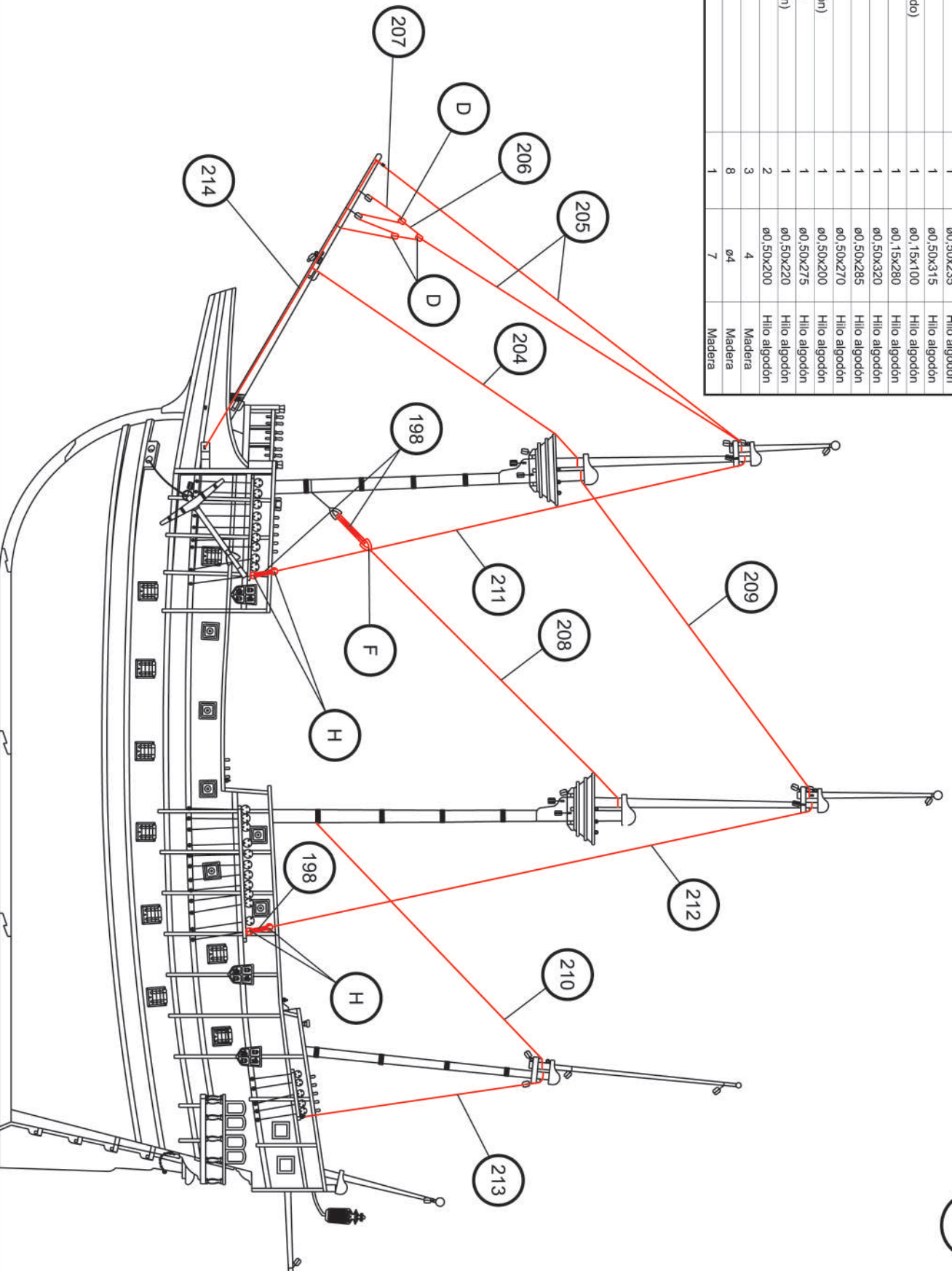

C

**Listado de piezas**

Nº	Descripción	Cantidad	Medidas	Materia
215	Driza verga trinquete (crudo)	1	ø0,15x285	Hilo algodón
216	Driza verga gavia trinquete (crudo)	1	ø0,15x360	Hilo algodón
217	Driza verga mayor (crudo)	1	ø0,15x340	Hilo algodón
218	Driza verga gavia mayor (crudo)	1	ø0,15x400	Hilo algodón

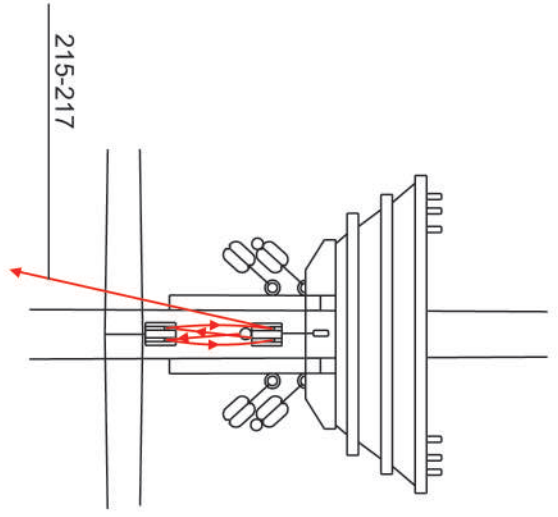

D

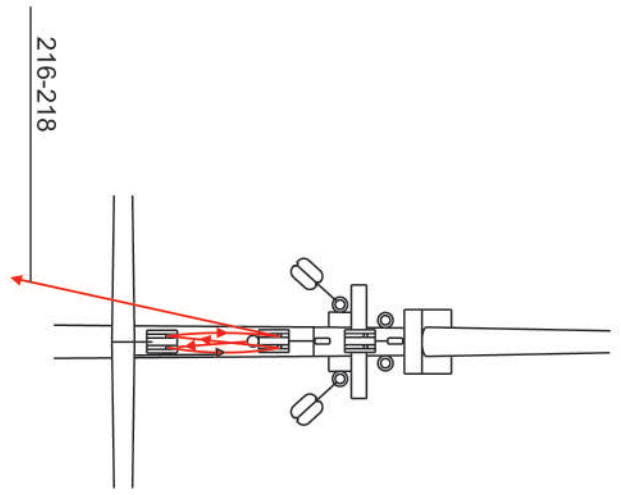

E

Listado de piezas

Nº	Descripción	Cantidad	Medidas	Material
219	Amanillios varga trinquete (crudo)	2	ø0,15x500	Hilo algodón
220	Amanillios varga gavia trinquete (crudo)	2	ø0,15x575	Hilo algodón
221	Amanillios varga mayor (crudo)	2	ø0,15x560	Hilo algodón
222	Amanillios varga gavia mayor (crudo)	2	ø0,15x625	Hilo algodón
223	Ditza varga cebadera (crudo)	1	ø0,15x260	Hilo algodón
224	Amanillios varga cebadera (crudo)	2	ø0,15x350	Hilo algodón

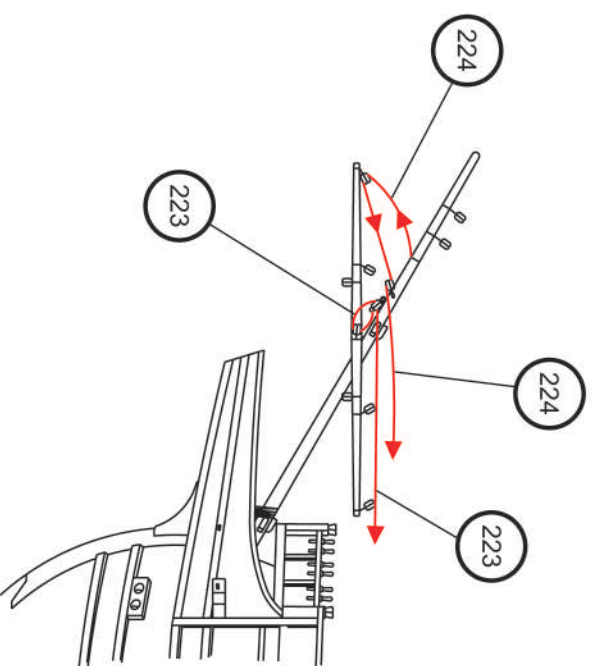
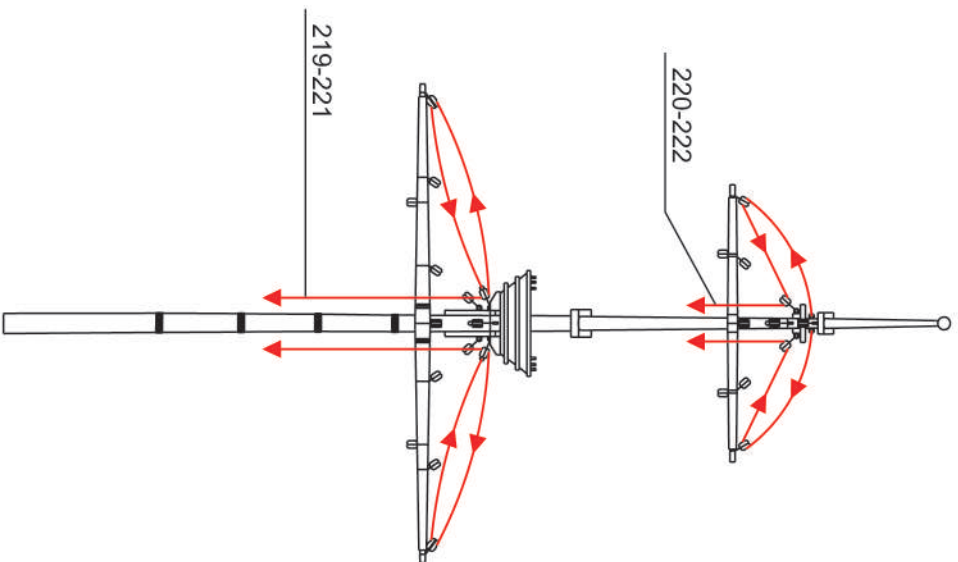

F



## Listado de piezas

Nº	Descripción	Cantidad	Medidas	Material
231	Brazas verga cebadera (crudo)	2	ø0,15x365	Hilo algodón
232	Brazas verga mayor (crudo)	2	ø0,15x460	Hilo algodón
233	Brazas verga gavía mayor (crudo)	2	ø0,15x685	Hilo algodón
E	Cuadernal	2	4	Madera

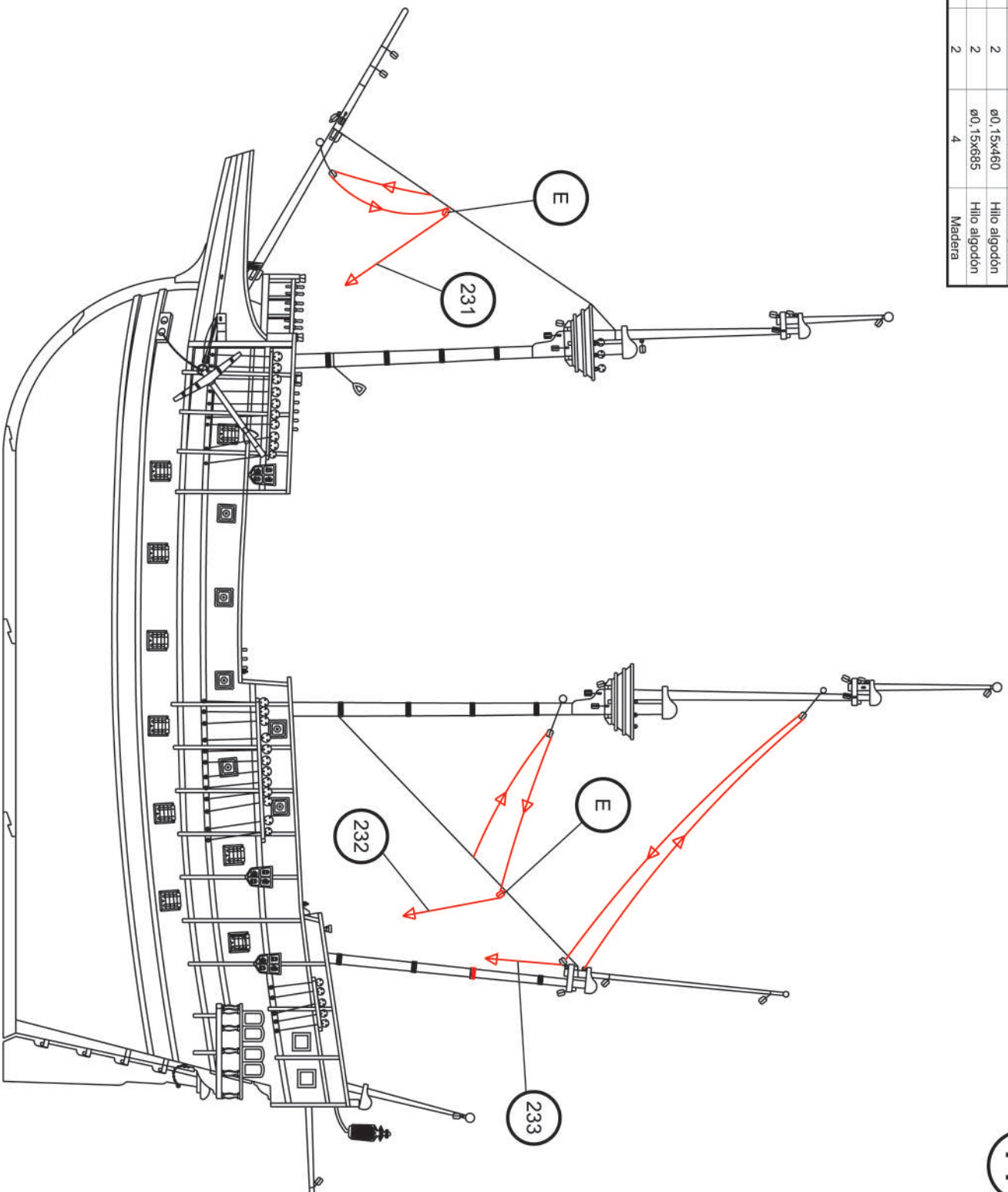

H

## Listado de piezas

Nº	Descripción	Cantidad	Medidas	Material
234	Vela cangreja	1		Tela
235	Amura de la cangreja (crudo)	1	ø0,15x130	Hilo algodón
236	Escota de la cangreja (crudo)	1	ø0,15x200	Hilo algodón
237	Cargaderas de la cangreja (crudo)	3	ø0,15x300	Hilo algodón
238	Apogapendoles cangreja (crudo)	1	ø0,15x350	Hilo algodón
239	Vela cebadera	1		Tela
240	Chatafideles de la cebadera (crudo)	2	ø0,15x435	Hilo algodón
241	Escotas de la cebadera (crudo)	2	ø0,15x500	Hilo algodón
242	Culdebra velas (crudo)	1	ø0,15x2500	Hilo algodón
D	Motón	4	4	Madera

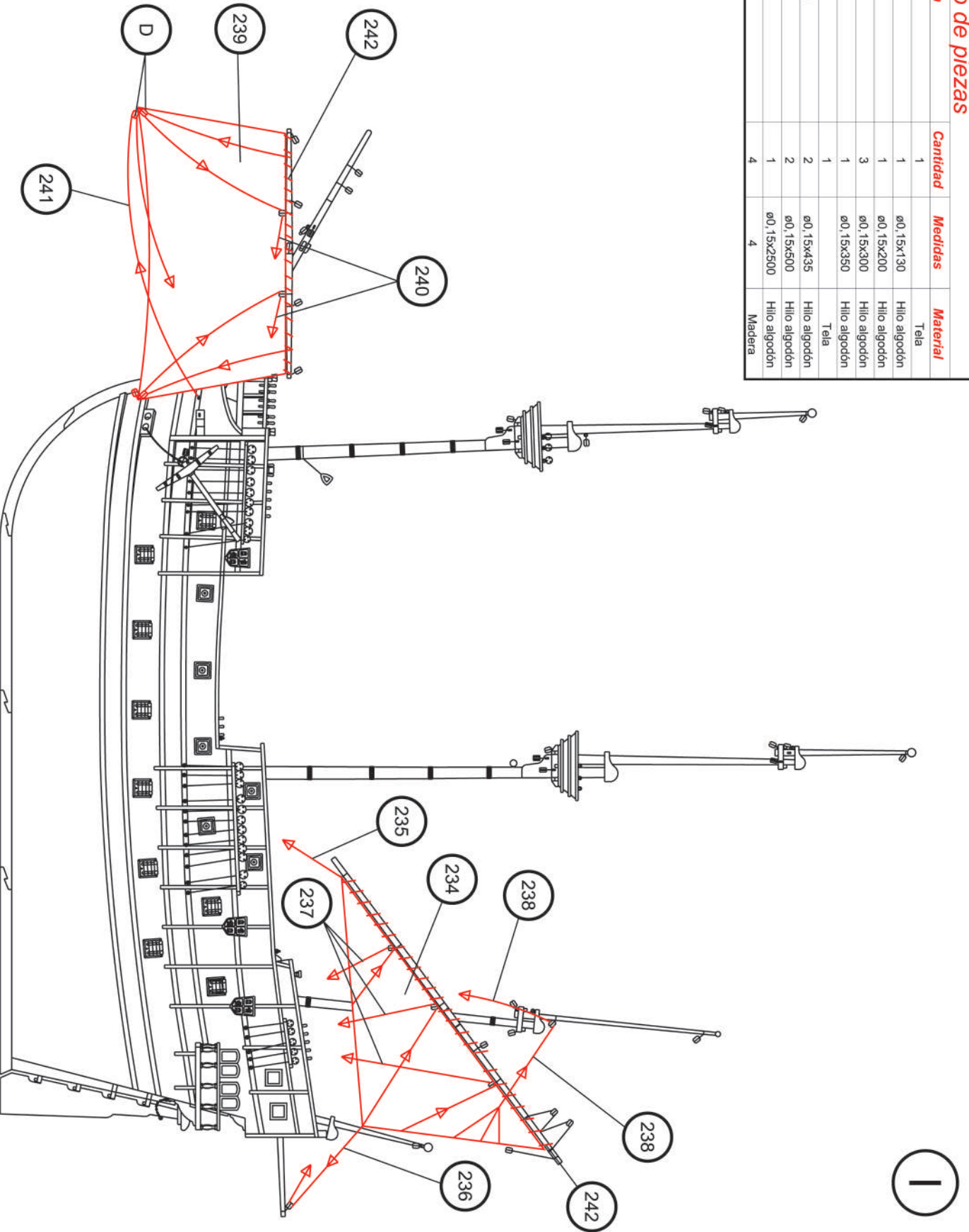

J

**Listado de piezas**

Nº	Descripción	Cantidad	Medidas	Material
242	Culebras velas (crudo)	1	ø0,15x2500	Hilo algodón
243	Vela trinquete	1	Tela	Tela
244	Charfaldetes vela trinquete (crudo)	2	ø0,15x325	Hilo algodón
245	Vela gavia trinquete	1	Tela	Tela
246	Charfaldetes gavia trinquete (crudo)	2	ø0,15x665	Hilo algodón
247	Escotas gavia trinquete (crudo)	2	ø0,15x560	Hilo algodón
248	Vela mayor	1	Tela	Tela
249	Charfaldetes vela mayor (crudo)	2	ø0,15x375	Hilo algodón
250	Vela gavia mayor	1	Tela	Tela
251	Charfaldetes de la gavia mayor (crudo)	2	ø0,15x720	Hilo algodón
252	Escotas de la gavia mayor (crudo)	2	ø0,15x625	Hilo algodón
253	Brioles trinquete (crudo)	2	ø0,15x450	Hilo algodón
254	Brioles gavia trinquete (crudo)	2	ø0,15x650	Hilo algodón
255	Brioles mayor (crudo)	2	ø0,15x500	Hilo algodón
256	Brioles de la gavia mayor (crudo)	2	ø0,15x745	Hilo algodón
D	Motón	8	4	Madera

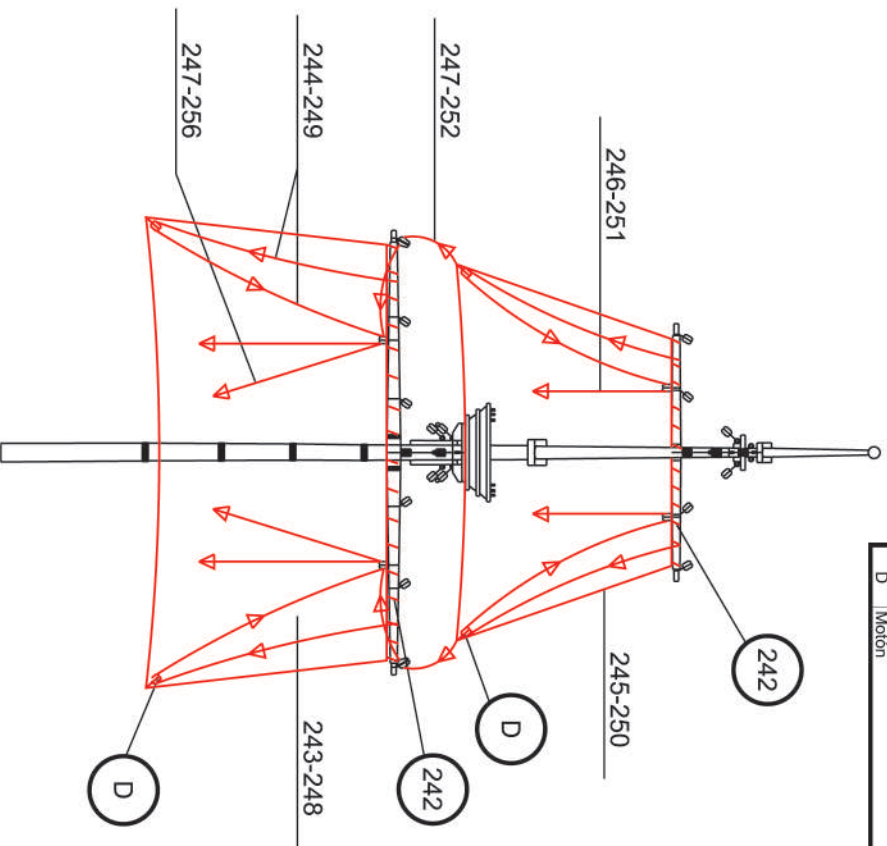

K

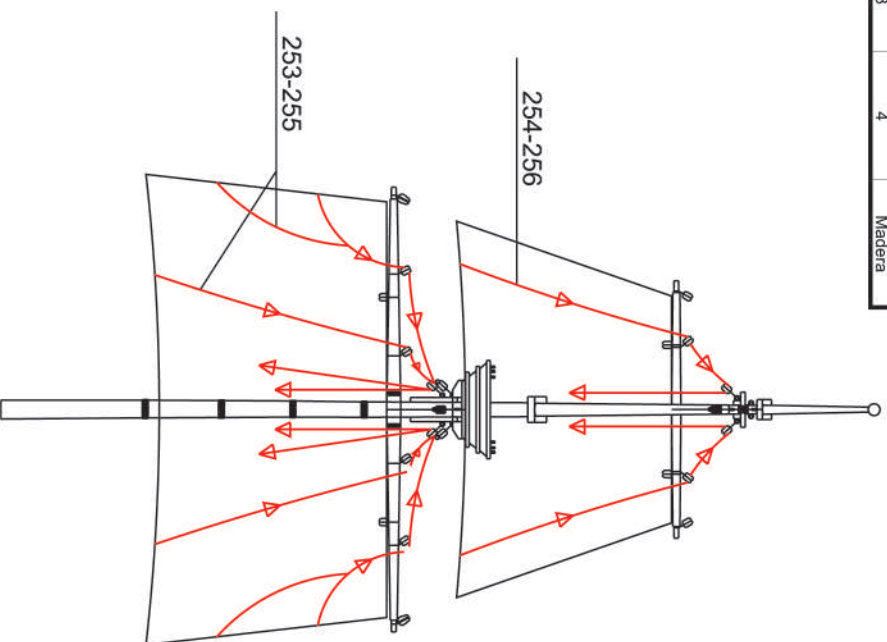

## Estado de piezas

Nº	Descripción	Cantidad	Medidas	Material
257	Brioles de la cebadera (crudo)	2	ø0,15x450	Hilo algodón
258	Escotas vela trinquete (crudo)	2	ø0,15x275	Hilo algodón
259	Bandarín	1		Tela
260	Driza del bandarín (crudo)	1	ø0,15x800	Hilo algodón
261	Escotas de la mayor (crudo)	2	ø0,15x265	Hilo algodón
262	Bandera mayor	1		Tela
263	Driza de la bandera del mayor (crudo)	1	ø0,15x820	Hilo algodón
264	Bandera popa	1		Tela
265	Driza bandera de popa (crudo)	1	ø0,15x225	Hilo algodón
D	Motón	4	4	Madera
E	Cuadernal	1	4	Madera

